

Perazzi

Armi Perazzi S.p.a. Via Fontanelle, 1 - 25080 Botticino Mattina - Brescia - Italy Tel. +39 030 26 96101 - Fax +39 030 26 92594
E-mail: marketing.sp@interbusiness.it

Perazzi Usa Inc. 1010 W. Tenth St. - Acacia, Ga. 91702 - Usa Phone: (620) 334-1234 - Fax (620) 334-0344
E-mail: PerazziUSA@aol.com

General Catalogue Game and Shotgun
Catalogo Generale Caccia e Tiro



The history of Armi Perazzi is the history of Daniele Perazzi, a poor but doggedly determined young man who chased the myth of a perfect gun and dreamt about becoming a gunsmith. At 16 he finally got a job in a large company proving his natural born talent and patenting one of his models. It is the first of a long series of guns, produced since the 1950's, that bears his name. In 1957 at the age of 25, Daniele Perazzi founded Armi Perazzi and established his own factory of which he remains the President. From the beginning Perazzi shooters achieved considerable success and the name and reputation of Perazzi became established and widely known. For 50 years Perazzi have built prestigious game and competition guns that are a fusion between traditional gunsmithing, high technology and the selection of excellent raw materials. The perfect balance and handling and the innovations that have been made during this time have resulted in a gun suitable for every discipline and made the company a world leader in clay shooting.



La storia della Armi Perazzi è la storia di Daniele Perazzi, un ragazzo poverissimo ma caparbio che da sempre insegue il mito del fucile perfetto e per questo sogna di diventare armaiolo. A soli sedici anni arriva finalmente il lavoro in una grande industria dove il giovane mette subito a frutto il suo innato talento brevettando un suo modello. E' il primo di una lunga serie di fucili che dagli anni cinquanta portano il suo nome. A 25 anni Daniele Perazzi ha la sua officina. I primi modelli vengono venduti direttamente sui campi da tiro dove la fama dell'armaiolo comincia a prendere piede grazie ai risultati eccellenti che i tiratori inanellano con i suoi fucili. Nel 1957 nasce la Armi Perazzi, l'azienda di cui è fondatore e ancora oggi Presidente. Da cinquant'anni la Perazzi realizza prestigiosi fucili da caccia e da competizione, frutto della sapiente fusione tra artigianato, alta tecnologia e scelta di materiali eccellenti.

Gli equilibri perfetti, la fluidità di brandeggio, l'elasticità e la maneggevolezza, le innovazioni che negli anni hanno reso i fucili Perazzi adatti ad ogni disciplina, fanno sì che l'azienda sia oggi leader mondiale nel settore del tiro a volo.



TABLE OF CONTENTS

PAGE

SET OF 4 GAME SHOTGUNS

from 20 to 51

Set Extra Super

20-31

Set Extra Gold

32-37

Set Extra

38-43

Set SCO Sideplates

44-45

Set SCO

46-47

Set SC3

48-49

Set SC2

50-51

GAME MODELS

from 52 to 59 and 96-97

12 ga

52-53

20 ga

54-55

28 ga

56-57

.410 ga

58-59

MX2000S 12 and 20 ga

96-97

DETAILS OF ENGRAVING PATTERNS

from 60 to 95

Extra Super

60-61

Extra Gold

62-65

Extra

66-71

SCO Gold Sideplates

72-73

SCO Sideplates

74-78

SCO Gold

79-81

SCO

82-89

SC3

90-95

COMPETITION MODELS

from 98 to 123

Olympic and double trap models

98-101

Sporting models

102-103

Skeet models

104-105

Pigeon and electrocibles models

106-107

American sporting models combo sets

108-109

American skeet models combo sets

110-111

American trap models single barrel

112-115

American trap models combo sets

116-123

INDICE

PAGINA

SET DI 4 FUCILI DA CACCIA

Set Extra Super	da 20 a 51
Set Extra Oro	20-31
Set Extra	32-37
Set SCO Cartelle	38-43
Set SCO	44-45
Set SC3	46-47
Set SC2	48-49
	50-51

MODELLI DA CACCIA

Cal. 12	da 52 a 59 e 96-97
Cal. 20	52-53
Cal. 28	54-55
Cal. .410	56-57
MX2000S cal. 12 e 20	58-59
	96-97

PARTICOLARI DELLE INCISIONI

Extra Super	da 60 a 95
Extra Oro	60-61
Extra	62-65
SCO Oro Cartelle	66-71
SCO Cartelle	72-73
SCO Oro	74-78
SCO	79-81
SC3	82-89
	90-95

MODELLI DA COMPETIZIONE

Modelli da fossa olimpica e double trap	da 98 a 123
Modelli da sporting	98-101
Modelli da skeet	102-103
Modelli da piccione ed eliche	104-105
Modelli da sporting combinati	106-107
Modelli da skeet combinati	108-109
Modelli da trap americano monocanna	110-111
Modelli da trap americano combinati	112-115
	116-123



Before you is our new catalogue which I have pleasure to introduce to you, but not before a warm invitation to visit the company that I founded together with my family and which has gained an enviable global reputation as it has grown. The product range is vast, fulfilling your requirements from game to competition and specifications to suit every need and desire.

I would be pleased to welcome you in the company to help you choose the gun that fits you perfectly.

Best regards

Daniele Perazzi

Ciò che state sfogliando è il nostro nuovo catalogo che ho il piacere di presentarVi non prima di averVi invitato a visitare l'azienda che ho fondato nel dopoguerra e che, insieme con la mia famiglia, ho portato ad espandersi fino ad essere rinomata in tutto il mondo. I fucili che ho concepito si adattano ad ogni tiratore ed ogni disciplina. La gamma è vasta e va dai modelli da caccia ai modelli da competizione variando tra modelli base e modelli lusso. Vi aspetto in fabbrica, come ogni mattina, con l'entusiasmo di sempre, insieme con i nostri artigiani, i nostri calciatori, i nostri tecnici, per aiutarVi a scegliere il fucile che più si adatta alle Vostre esigenze e caratteristiche.

Un caro saluto

Daniele Perazzi

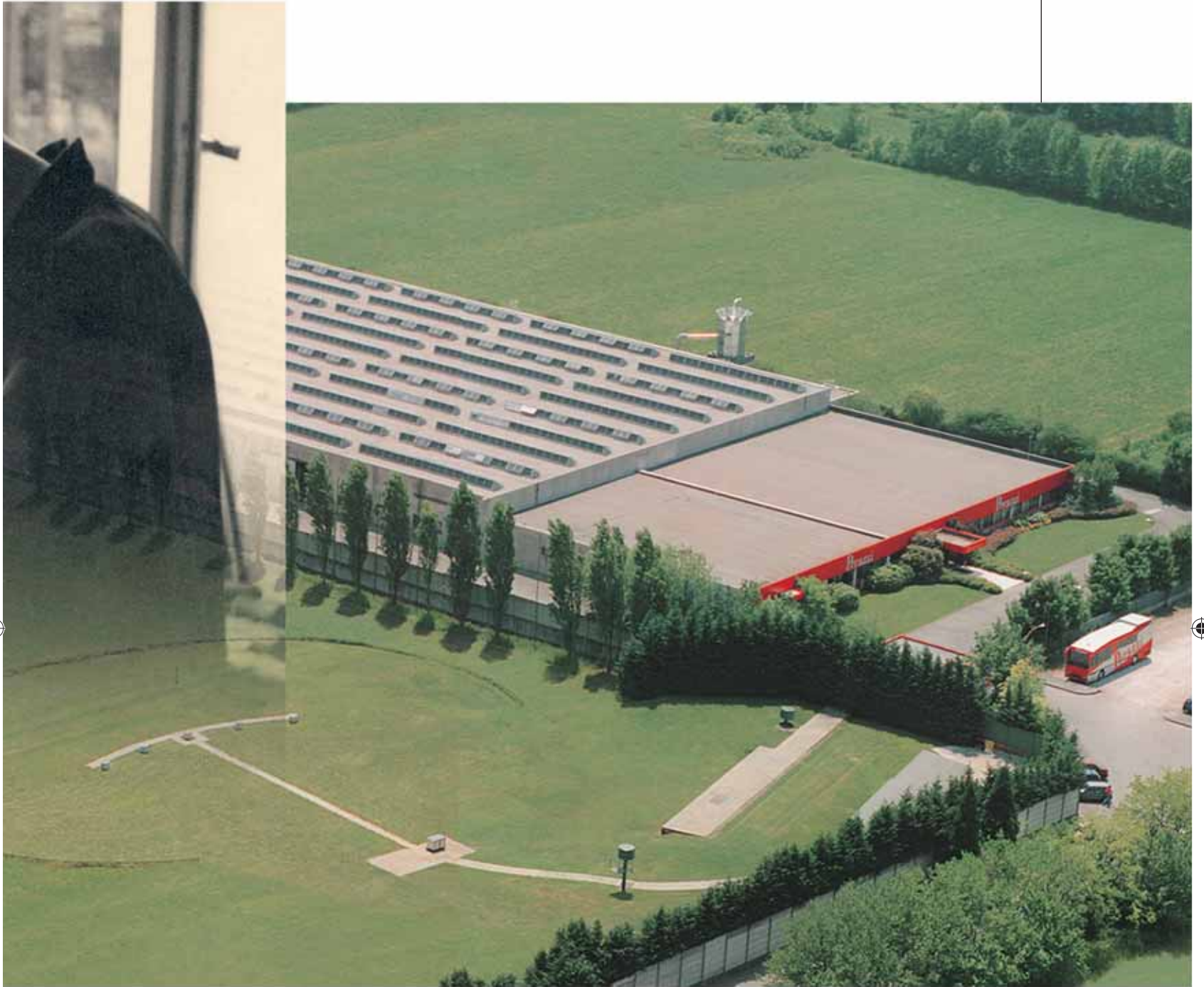

Perazzi





Perazzi





Perazzi services the American market through its subsidiary Perazzi USA Inc. located in Azusa – California. Perazzi USA acts as importer and distributor for Perazzi products in the United States and Canadian markets. Customers are welcome to visit the showroom where most representative models are displayed.

La Armi Perazzi opera direttamente sul mercato americano con la Perazzi U.S.A. Inc. che ha sede ad Azusa in California. La filiale americana distribuisce i prodotti Perazzi direttamente in territorio statunitense e canadese. I clienti possono visionare i modelli più rappresentativi della nostra gamma esposti nel vasto show room predisposto a tal scopo.

USA





The large lobby of the company serves as showroom for our product range of game and competition guns, where our customers have the possibility to closely examine our products. In our brand new showroom "Perazzi Style" you will find clothing and accessories for game, competition or just for casual wear.

Nell'ampio salone dell'azienda, adibito all'esposizione dei modelli principali da caccia e da tiro, i clienti hanno la possibilità di visionare da vicino i nostri fucili.

Nel nuovissimo show room "Perazzi Style" sono esposti tutti i nostri accessori ed i capi d'abbigliamento specifici per la caccia o espressamente creati per lo sport del tiro a volo o disegnati per il semplice tempo libero.





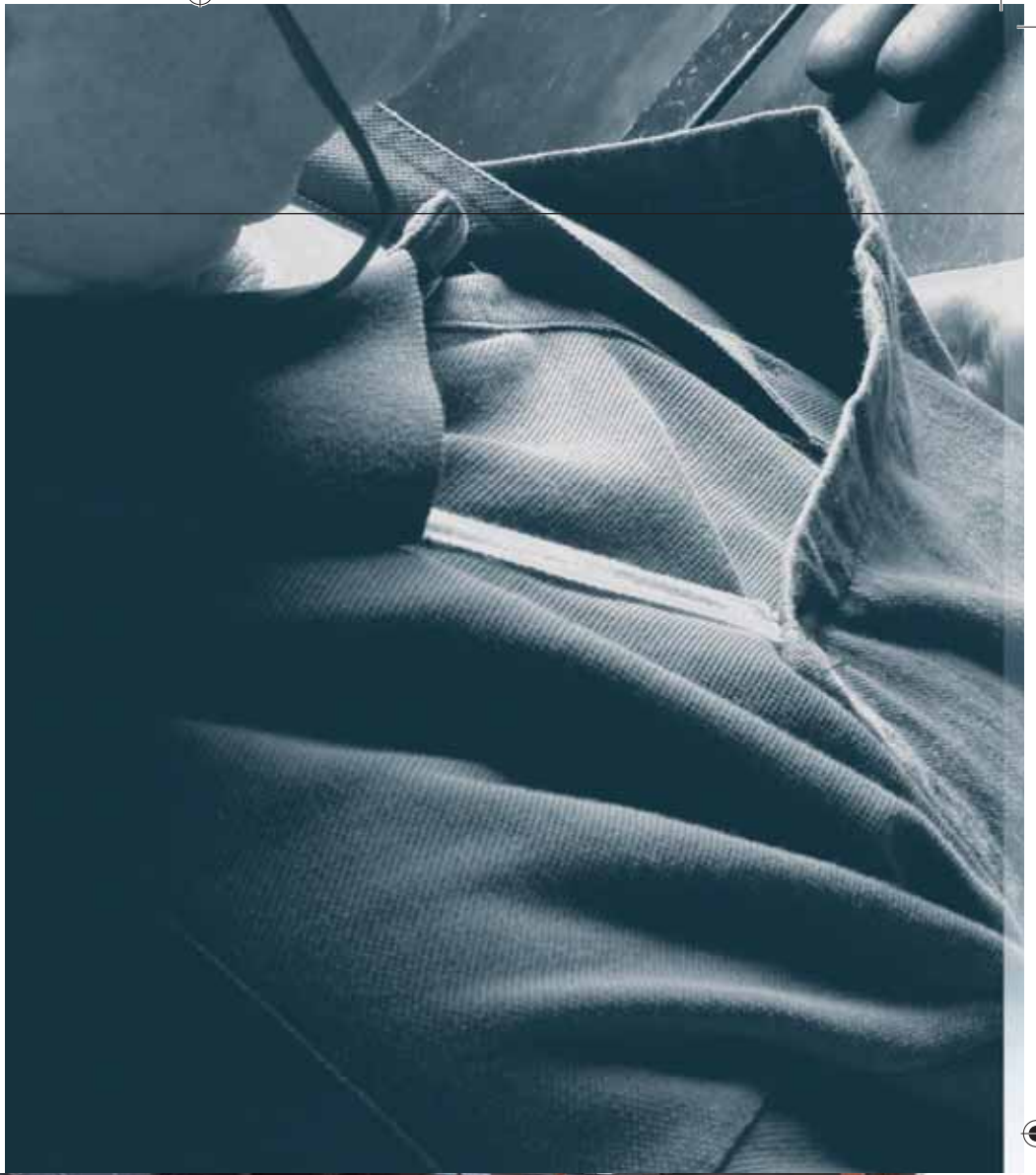



The assembly line is where the guns are made. All operations involving the fitting of the various components are executed strictly by hand using highly skilled gunsmiths. The whole process starts with the serialization of the guns and ends with the final control to certify the compliance of the model to the customer's specifications.

Il reparto montaggio è il luogo dove ogni fucile prende vita e forma. Le operazioni inerenti alla perfetta interazione dei vari componenti del fucile vengono eseguite esclusivamente a mano da esperti armaioli.

Ogni fase, dalla immatricolazione al controllo finale, è eseguita al fine di assicurare la totale compatibilità del modello alle specifiche richieste del cliente.







The barrel department provides for the perfect execution of the parts to ensure the highest performance of the whole gun. For this reason, Perazzi puts the outmost care during the whole process, from the rough boring, to the rib soldering and the straightness control which is still done by relying on the human eye.

All the components of the gun are made according to strict and precise dimension standards. All the parts are made inside the factory using the most modern and updated CNC machines, specifically set up by the manufacturer to conform to our strict standards.

Il reparto canne provvede alla perfetta realizzazione delle stesse, garantendo prestazioni ad altissimo livello dell'intero fucile. Per questa ragione viene prestata la massima cura in tutte le singole fasi di assemblaggio e di lavoro, dalla foratura dei tubi alla saldatura delle bindelle fino alla raddrizzatura delle canne che viene ancora eseguita mediante occhio umano.

Tutti i componenti del fucile sono prodotti all'interno della fabbrica e debbono conformarsi a precise e severe caratteristiche tecniche.

La realizzazione e produzione delle singole parti viene eseguita dai più moderni e sofisticati centri di lavoro a controllo numerico appositamente predisposti per attenersi alle micrometriche esigenze di qualità da noi richieste.





Stocks and forends are made of best quality walnut, obtained from centuries old trees like the one shown in the picture. The blanks are individually selected and graded and, before they can be used, they must undergo a long drying process. Our skilled stock makers can produce, within a few hours, customized stocks and forends according to the demands and physical characteristics of the shooter.

Calci e aste sono di noce della migliore qualità, ricavati da tronchi pluricentenari come quello raffigurato nella fotografia. Ogni abbozzo viene selezionato e classificato singolarmente e, prima di essere utilizzato per un fucile, viene sottoposto ad un lungo processo di essiccazione.

I nostri esperti calcisti provvedono poi a creare, in poche ore, calci e aste su misura, secondo le esigenze tecniche e caratteristiche fisiche del tiratore.



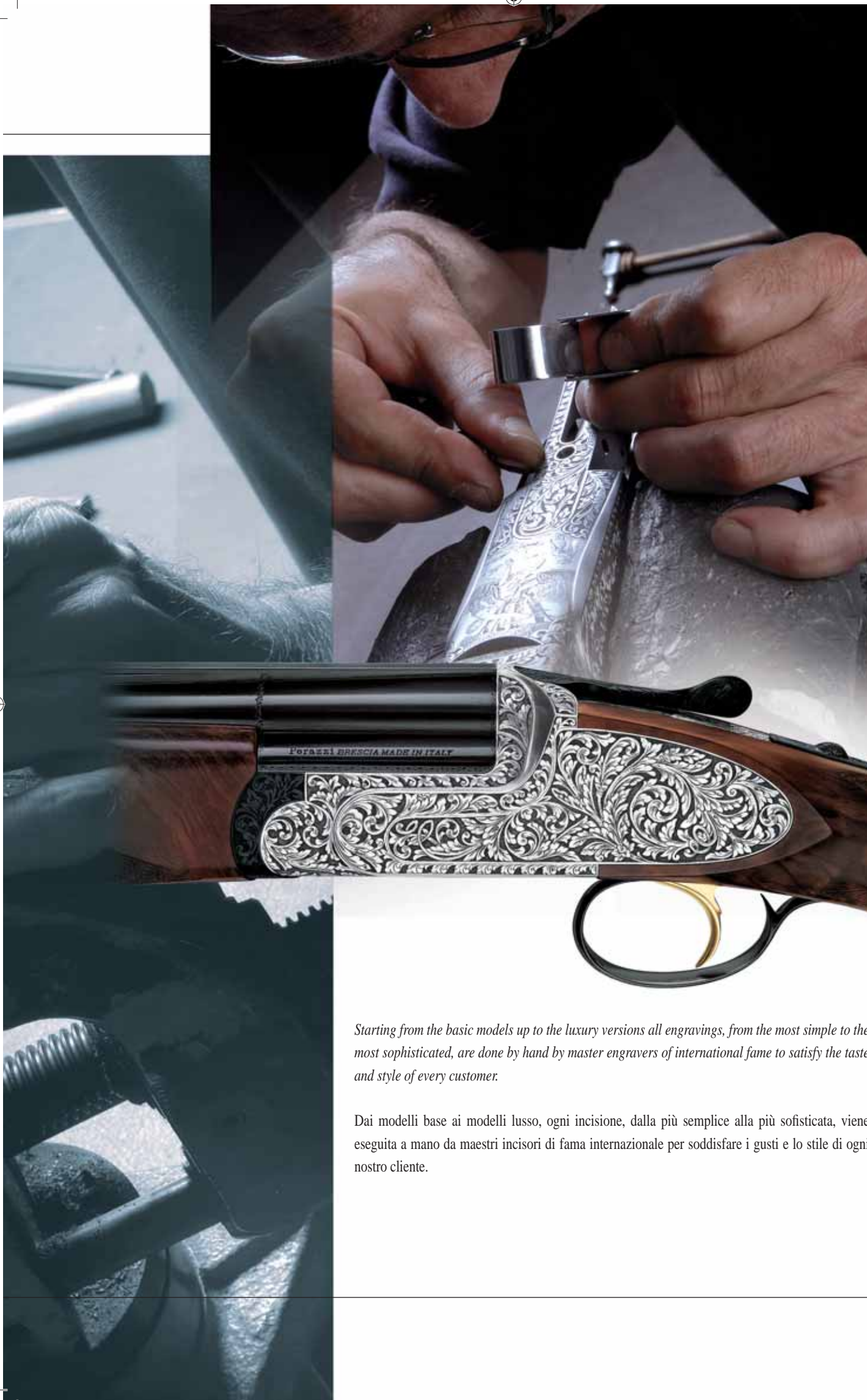

Starting from the basic models up to the luxury versions all engravings, from the most simple to the most sophisticated, are done by hand by master engravers of international fame to satisfy the taste and style of every customer.

Dai modelli base ai modelli lusso, ogni incisione, dalla più semplice alla più sofisticata, viene eseguita a mano da maestri incisori di fama internazionale per soddisfare i gusti e lo stile di ogni nostro cliente.





The service department has been created especially for our visitors, where they can meet us and ask for all kind of assistance, or to discuss choosing a new gun.

The reputation of Perazzi shotguns is not only due to its high quality but also due to the excellent service Armi Perazzi is supplying with them. The shooters can even test their guns in the shooting range for Olympic Trap, Double Trap and Skeet that is situated next to the production facilities.

The service department is also mobile. Our big service vehicle is throughout the year on the road at shooting ranges attending the shooters at important domestic and international events.

Il reparto servizio clienti è espressamente realizzato per i visitatori, i quali possono incontrare il costruttore per ogni tipo di assistenza o per la realizzazione di un nuovo fucile o ancora, per la fabbricazione delle parti in legno e per la messa a punto dell'arma nel tunnel di sparo con la placca per le rosate.

La rinomanza mondiale dei fucili Perazzi non deriva solo dalla intrinseca qualità del prodotto ma anche dal servizio tecnico che con esso viene offerto. I tiratori possono persino provare i loro fucili sul campo da tiro adiacente la fabbrica allestito per Fossa Olimpica, Double Trap e Skeet.

Ma il reparto clienti è anche mobile. La nostra grande autofficina infatti si sposta tutto l'anno, presenziando alle più importanti manifestazioni della stagione agonistica per assistere i tiratori, direttamente sul campo da tiro durante le competizioni.



SET EXTRA SUPER

12, 20, 28 AND .410 GA



No. 1 12 ga | cal. 12



No. 2 20 ga | cal. 20



No. 3 28 ga | cal. 28



No. 4 .410 ga | cal. .410

Barrel length and chokes	26 3/4" - 27 9/16" - 28 3/8" - 29 1/2" - 4 and 8/10 or on request or with interchangeable chokes
Rib and side ribs	Flat parallel rib 9/32" x 9/32". With half solid side ribs
Trigger group	Non removable, single selective with coil springs
Stock and forend	English style or pistol grip - Game forend

SET EXTRA SUPER

CALIBRO 12, 20, 28 E .410



Lunghezza canne e strozzature	68-70-72-75 cm - 4 e 8/10 o a richiesta o con strozzatori intercambiabili
Bindella e bindellini	Bindella piana parallela 7 x 7 mm. Con mezzi bindellini pieni
Batteria	Fissa con molle a spirale e selettore sulla sicura
Calcio e asta	Calcio inglese o a pistola - Asta caccia

SET EXTRA SUPER

12 ga Model
Details of engraving No. 901

Modello cal. 12
Particolari dell'incisione No. 901



Left side | Lato sinistro



Right side | Lato destro



Bottom | Lato inferiore

SET EXTRA SUPER

20 ga Model
Details of engraving No. 902

Modello cal. 20
Particolari dell'incisione No. 902



Left side | Lato sinistro



Right side | Lato destro



Bottom | Lato inferiore

SET EXTRA SUPER

28 ga Model
Details of engraving No. 903

Modello cal. 28
Particolari dell'incisione No. 903



Left side | Lato sinistro



Right side | Lato destro



Bottom | Lato inferiore

SET EXTRA SUPER

.410 ga Model
Details of engraving No. 904

Modello cal. .410
Particolari dell'incisione No. 904



Left side | Lato sinistro



Right side | Lato destro



Bottom | Lato inferiore

SET EXTRA SUPER

12, 20, 28 AND .410 GA



No. 1 12 ga | cal. 12



No. 2 20 ga | cal. 20



No. 3 28 ga | cal. 28



No. 4 .410 ga | cal. .410

Barrel length and chokes	26 3/4" - 27 9/16" - 28 3/8" - 29 1/2" - 4 and 8/10 or on request or with interchangeable chokes
Rib and side ribs	Flat parallel rib 9/32" x 9/32". With half solid side ribs
Trigger group	Non removable, single selective with coil springs
Stock and forend	English style or pistol grip - Game forend

SET EXTRA SUPER

CALIBRO 12, 20, 28 E .410



Lunghezza canne e strozzature	68-70-72-75 cm - 4 e 8/10 o a richiesta o con strozzatori intercambiabili
Bindella e bindellini	Bindella piana parallela 7 x 7 mm. Con mezzi bindellini pieni
Batteria	Fissa con molle a spirale e selettore sulla sicura
Calcio e asta	Calcio inglese o a pistola - Asta caccia

SET EXTRA SUPER

12 ga Model
Details of engraving No. 905

Modello cal. 12
Particolari dell'incisione No. 905



Left side | Lato sinistro



Right side | Lato destro

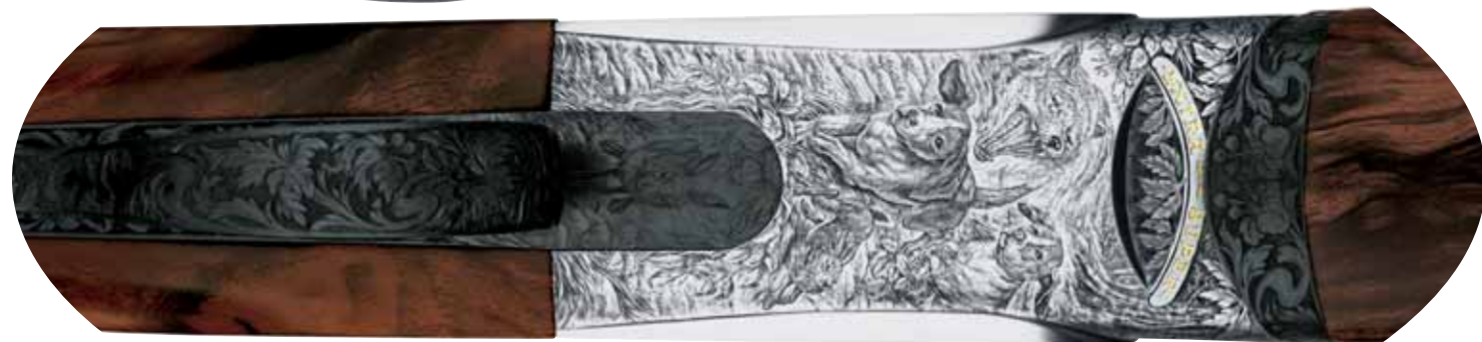

Bottom | Lato inferiore

SET EXTRA SUPER

20 ga Model
Details of engraving No. 906

Modello cal. 20
Particolari dell'incisione No. 906



Left side | Lato sinistro



Right side | Lato destro



Bottom | Lato inferiore

SET EXTRA SUPER

28 ga Model
Details of engraving No. 907

Modello cal. 28
Particolari dell'incisione No. 907



Left side | Lato sinistro



Right side | Lato destro



Bottom | Lato inferiore

SET EXTRA SUPER

.410 ga Model
Details of engraving No. 908

Modello cal. .410
Particolari dell'incisione No. 908



Left side | Lato sinistro



Right side | Lato destro



Bottom | Lato inferiore



SET EXTRA GOLD

12, 20, 28 AND .410 GA



No. 1 12 ga | cal. 12



No. 2 20 ga | cal. 20



No. 3 28 ga | cal. 28



No. 4 .410 ga | cal. .410

Barrel length and chokes	26 3/4" - 27 9/16" - 28 3/8" - 29 1/2" - 4 and 8/10 or on request or with interchangeable chokes
Rib and side ribs	Flat parallel rib 9/32" x 9/32". With half solid side ribs
Trigger group	Non removable, single selective with coil springs
Stock and forend	English style or pistol grip - Game forend



SET EXTRA ORO

CALIBRO 12, 20, 28 E .410



Lunghezza canne e strozzature	68-70-72-75 cm - 4 e 8/10 o a richiesta o con strozzatori intercambiabili
Bindella e bindellini	Bindella piana parallela 7 x 7 mm. Con mezzi bindellini pieni
Batteria	Fissa con molle a spirale e selettore sulla sicura
Calcio e asta	Calcio inglese o a pistola - Asta caccia

SET EXTRA GOLD

12 ga Model
Details of engraving No. 850

Modello cal. 12
Particolari dell'incisione No. 850



Left side | Lato sinistro



Right side | Lato destro



Bottom | Lato inferiore

SET EXTRA ORO

20 ga Model
Details of engraving No. 851

Modello cal. 20
Particolari dell'incisione No. 851



Left side | Lato sinistro



Right side | Lato destro



Bottom | Lato inferiore

SET EXTRA GOLD

28 ga Model
Details of engraving No. 852

Modello cal. 28
Particolari dell'incisione No. 852



Left side | Lato sinistro



Right side | Lato destro



Bottom | Lato inferiore

SET EXTRA ORO

.410 ga Model
Details of engraving No. 853

Modello cal. 410
Particolari dell'incisione No. 853



Left side | Lato sinistro



Right side | Lato destro



Bottom | Lato inferiore

SET EXTRA

12, 20, 28 AND .410 GA



No. 1 12 ga | cal. 12



No. 2 20 ga | cal. 20



No. 3 28 ga | cal. 28



No. 4 .410 ga | cal. .410

Barrel length and chokes	26 3/4" - 27 9/16" - 28 3/8" - 29 1/2" - 4 and 8/10 or on request or with interchangeable chokes
Rib and side ribs	Flat parallel rib 9/32" x 9/32". With half solid side ribs
Trigger group	Non removable, single selective with coil springs
Stock and forend	English style or pistol grip - Game forend

SET EXTRA

CALIBRO 12, 20, 28 E .410



Lunghezza canne e strozzature	68-70-72-75 cm - 4 e 8/10 o a richiesta o con strozzatori intercambiabili
Bindella e bindellini	Bindella piana parallela 7 x 7 mm. Con mezzi bindellini pieni
Batteria	Fissa con molle a spirale e selettore sulla sicura
Calcio e asta	Calcio inglese o a pistola - Asta caccia

SET EXTRA

12 ga Model
Details of engraving

Modello cal. 12
Particolari dell'incisione



Left side | Lato sinistro No. 818



Right side | Lato destro No. 827



Bottom | Lato inferiore No. 840

SET EXTRA

20 ga Model
Details of engraving

Modello cal. 20
Particolari dell'incisione



Left side | Lato sinistro No. 841



Right side | Lato destro No. 842



Bottom | Lato inferiore No. 843

SET EXTRA

28 ga Model
Details of engraving

Modello cal. 28
Particolari dell'incisione



Left side | Lato sinistro No. 811



Right side | Lato destro No. 814



Bottom | Lato inferiore No. 801

SET EXTRA

.410 ga Model
Details of engraving

Modello cal. .410
Particolari dell'incisione



Left side | Lato sinistro No. 803



Right side | Lato destro No. 803



Bottom | Lato inferiore No. 803



SET SCO SIDEPLATES

12, 20, 28 AND .410 GA

Engravings can be chosen among the SCO Sideplates patterns shown in this catalogue from page 74 through 78



No. 1 12 ga | cal. 12



No. 2 20 ga | cal. 20



No. 3 28 ga | cal. 28



No. 4 .410 ga | cal. .410

Barrel length and chokes	26 3/4" - 27 9/16" - 28 3/8" - 29 1/2" - 4 and 8/10 or on request or with interchangeable chokes
Rib and side ribs	Flat parallel rib 9/32" x 9/32". With half solid side ribs
Trigger group	Non removable, single selective with coil springs
Stock and forend	English style or pistol grip - Game forend



SET SCO CARTELLE

CALIBRO 12, 20, 28 E .410

Le incisioni possono essere scelte fra i tipi SCO Cartelle presentati in questo catalogo da pag.74 a pag.78



Lunghezza canne e strozzature	68-70-72-75 cm - 4 e 8/10 o a richiesta o con strozzatori intercambiabili
Bindella e bindellini	Bindella piana parallela 7 x 7 mm. Con mezzi bindellini pieni
Batteria	Fissa con molle a spirale e selettore sulla sicura
Calcio e asta	Calcio inglese o a pistola - Asta caccia



SET SCO

12, 20, 28 AND .410 GA

Engravings can be chosen among the SCO patterns shown in this catalogue from page 82 through 89



No. 1 12 ga | cal. 12



No. 2 20 ga | cal. 20



No. 3 28 ga | cal. 28



No. 4 .410 ga | cal. .410

Barrel length and chokes	26 3/4" - 27 9/16" - 28 3/8" - 29 1/2" - 4 and 8/10 or on request or with interchangeable chokes
Rib and side ribs	Flat parallel rib 9/32" x 9/32". With half solid side ribs
Trigger group	Non removable, single selective with coil springs
Stock and forend	English style or pistol grip - Game forend



SET SCO

CALIBRO 12, 20, 28 E .410

Le incisioni possono essere scelte fra i tipi SCO presentati in questo catalogo da pag. 82 a pag. 89



Lunghezza canne e strozzature	68-70-72-75 cm - 4 e 8/10 o a richiesta o con strozzatori intercambiabili
Bindella e bindellini	Bindella piana parallela 7 x 7 mm. Con mezzi bindellini pieni
Batteria	Fissa con molle a spirale e selettore sulla sicura
Calcio e asta	Calcio inglese o a pistola - Asta caccia

SET SC3

12, 20, 28 AND .410 GA

Engravings can be chosen among the SC3 patterns shown in this catalogue from page 90 through 95



No. 1 12 ga | cal. 12



No. 2 20 ga | cal. 20



No. 3 28 ga | cal. 28



No. 4 .410 ga | cal. .410

Barrel length and chokes	26 3/4" - 27 9/16" - 28 3/8" - 29 1/2" - 4 and 8/10 or on request or with interchangeable chokes
Rib and side ribs	Flat parallel rib 9/32" x 9/32". With half solid side ribs
Trigger group	Non removable, single selective with coil springs
Stock and forend	English style or pistol grip - Game forend

SET SC3

CALIBRO 12, 20, 28 E .410

Le incisioni possono essere scelte fra i tipi SC3 presentati in questo catalogo da pag.90 a pag.95



Lunghezza canne e strozzature	68-70-72-75 cm - 4 e 8/10 o a richiesta o con strozzatori intercambiabili
Bindella e bindellini	Bindella piana parallela 7 x 7 mm. Con mezzi bindellini pieni
Batteria	Fissa con molle a spirale e selettore sulla sicura
Calcio e asta	Calcio inglese o a pistola - Asta caccia

SET SC2

12, 20, 28 AND .410 GA

Available with engraving No. 101 only



No. 1 12 ga | cal. 12



No. 2 20 ga | cal. 20



No. 3 28 ga | cal. 28



No. 4 .410 ga | cal. .410

Barrel length and chokes	26 3/4" - 27 9/16" - 28 3/8" - 29 1/2" - 4 and 8/10 or on request or with interchangeable chokes
Rib and side ribs	Flat parallel rib 9/32" x 9/32". With half solid side ribs
Trigger group	Non removable, single selective with coil springs
Stock and forend	English style or pistol grip - Game forend

SET SC2

CALIBRO 12, 20, 28 E .410

Disponibile solamente con incisione No. 101



Lunghezza canne e strozzature	68-70-72-75 cm - 4 e 8/10 o a richiesta o con strozzatori intercambiabili
Bindella e bindellini	Bindella piana parallela 7 x 7 mm. Con mezzi bindellini pieni
Batteria	Fissa con molle a spirale e selettore sulla sicura
Calcio e asta	Calcio inglese o a pistola - Asta caccia

GAME MODELS 12 GA



MX12 Extra



MX12 SCO Sideplates | MX12 SCO Cartelle



MX12 SCO



MX12 SC3



MX12 Standard

Barrel length and chokes	26 3/4" - 27 9/16" - 28 3/8" - 29 1/2" - 4 and 8/10 or on request or interchangeable chokes
Rib and side ribs	Flat parallel rib 9/32" x 9/32". With half solid side ribs
Trigger group	Non removable, single selective with coil springs
Stock and forend	English style or pistol grip - Game forend

MODELLI DA CACCIA CAL. 12



Lunghezza canne e strozzature	68-70-72-75 cm - 4 e 8/10 o a richiesta o con strozzatori intercambiabili
Bindella e bindellini	Bindella piana parallela 7 x 7 mm. Con mezzi bindellini pieni
Batteria	Fissa con molle a spirale e selettore sulla sicura
Calcio e asta	Calcio inglese o a pistola - Asta caccia

GAME MODELS 20 GA



MX20 Extra



MX20 SCO Sideplates | MX20 SCO Cartelle



MX20 SCO



MX20 SC3



MX20 Standard

Barrel length and chokes	26 3/4" - 27 9/16" - 28 3/8" - 29 1/2" - 4 and 8/10 or on request or interchangeable chokes
Rib and side ribs	Flat parallel rib 9/32" x 9/32". With half solid side ribs
Trigger group	Non removable, single selective with coil springs
Stock and forend	English style or pistol grip - Game forend

MODELLI DA CACCIA CAL. 20



Lunghezza canne e strozzature	68-70-72-75 cm - 4 e 8/10 o a richiesta o con strozzatori intercambiabili
Bindella e bindellini	Bindella piana parallela 7 x 7 mm. Con mezzi bindellini pieni
Batteria	Fissa con molle a spirale e selettore sulla sicura
Calcio e asta	Calcio inglese o a pistola - Asta caccia

GAME MODELS 28 GA



MX28 Extra



MX28 SCO Sideplates | MX28 SCO Cartelle



MX28 SCO



MX28 SC3



MX28 Standard

Barrel length and chokes	26 3/4" - 27 9/16" - 28 3/8" - 29 1/2" - 4 and 8/10 or on request or interchangeable chokes
Rib and side ribs	Flat parallel rib 9/32" x 9/32". With half solid side ribs
Trigger group	Non removable, single selective with coil springs
Stock and forend	English style or pistol grip - Game forend

MODELLI DA CACCIA CAL. 28



Lunghezza canne e strozzature	68-70-72-75 cm - 4 e 8/10 o a richiesta o con strozzatori intercambiabili
Bindella e bindellini	Bindella piana parallela 7 x 7 mm. Con mezzi bindellini pieni
Batteria	Fissa con molle a spirale e selettore sulla sicura
Calcio e asta	Calcio inglese o a pistola - Asta caccia

GAME MODELS .410 GA



MX410 Extra



MX410 SCO Sideplates | MX410 SCO Cartelle



MX410 SCO



MX410 SC3



MX410 Standard

Barrel length and chokes	26 3/4" - 27 9/16" - 28 3/8" - 29 1/2" - 4 and 8/10 or on request or interchangeable chokes
Rib and side ribs	Flat parallel rib 9/32" x 9/32". With half solid side ribs
Trigger group	Non removable, single selective with coil springs
Stock and forend	English style or pistol grip - Game forend

MODELLI DA CACCIA CAL. .410



Lunghezza canne e strozzature	68-70-72-75 cm - 4 e 8/10 o a richiesta o con strozzatori intercambiabili
Bindella e bindellini	Bindella piana parallela 7 x 7 mm. Con mezzi bindellini pieni
Batteria	Fissa con molle a spirale e selettore sulla sicura
Calcio e asta	Calcio inglese o a pistola - Asta caccia

EXTRA SUPER

Engraving patterns applicable to any Extra Super version



Left side | Lato sinistro No. 912



Right side | Lato destro No. 912



Bottom | Lato inferiore No. 912

EXTRA SUPER

Tipi di incisione applicabili a qualsiasi versione Extra Super



Left side | Lato sinistro No. 920



Right side | Lato destro No. 920



Botton | Lato inferiore No. 920

EXTRA GOLD

Engraving patterns applicable to any Extra Gold version



Left side | Lato sinistro No. 854



Right side | Lato destro No. 855



Bottom | Lato inferiore No. 856

EXTRA ORO

Tipi di incisione applicabili a qualsiasi versione Extra Oro



Left side | Lato sinistro No. 85



Right side | Lato destro No. 86



Bottom | Lato inferiore No. 87

EXTRA GOLD

Engraving patterns applicable to any Extra Gold version



Left side | Lato sinistro No. 858



Right side | Lato destro No. 859



Bottom | Lato inferiore No. 860

EXTRA ORO

Tipi di incisione applicabili a qualsiasi versione Extra Oro



Left side | Lato sinistro No. 861



Right side | Lato destro No. 862



Bottom | Lato inferiore No. 863

EXTRA

Engraving patterns applicable to any Extra version



Left side | Lato sinistro No. 831



Right side | Lato destro No. 832



Bottom | Lato inferiore No. 833

EXTRA

Tipi di incisione applicabili a qualsiasi versione Extra



Left side | Lato sinistro No. 828



Right side | Lato destro No. 829



Bottom | Lato inferiore No. 830

EXTRA

Engraving patterns applicable to any Extra version



Left side | Lato sinistro No. 834



Right side | Lato destro No. 835



Bottom | Lato inferiore No. 836

EXTRA

Tipi di Incisione applicabili a qualsiasi versione Extra



Left side | Lato sinistro No. 837



Right side | Lato destro No. 838



Bottom | Lato inferiore No. 839

EXTRA

Engraving patterns applicable to any Extra version



Left side | Lato sinistro No. 82



Right side | Lato destro No. 813



Bottom | Lato inferiore No. 844

EXTRA

Tipi di Incisione applicabili a qualsiasi versione Extra



Left side | Lato sinistro No. 804



Right side | Lato destro No. 804



Bottom | Lato inferiore No. 804

SCO GOLD SIDEPLATES

Engraving patterns applicable to any SCO Gold Sideplates version



Left side | Lato sinistro No. 44



Right side | Lato destro No. 45

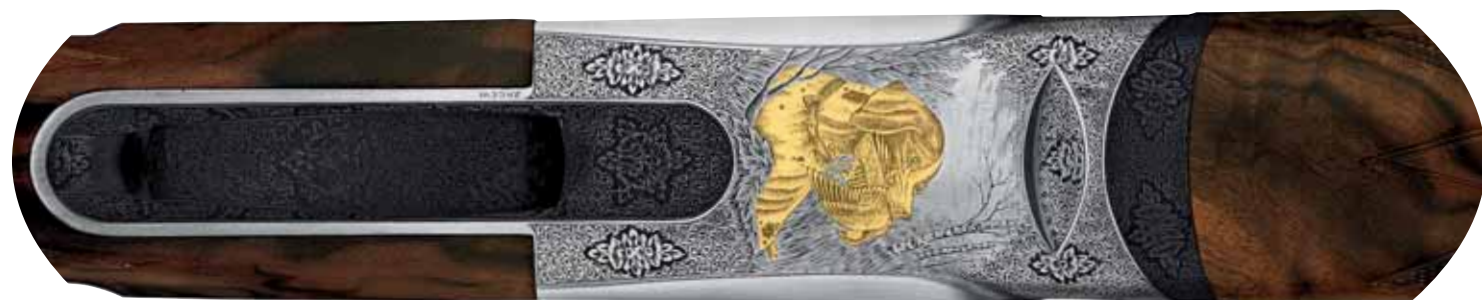

Bottom | Lato inferiore No. 46

SCO ORO CARTELLE

Tipi di incisione applicabili a qualsiasi versione SCO Oro Cartelle



Left side | Lato sinistro No. 42



Right side | Lato destro No. 41



Bottom | Lato inferiore No. 410

SCO SIDEPLATES

Engraving patterns applicable to any SCO Sideplates version



Left side | Lato sinistro No. 32



Right side | Lato destro No. 43

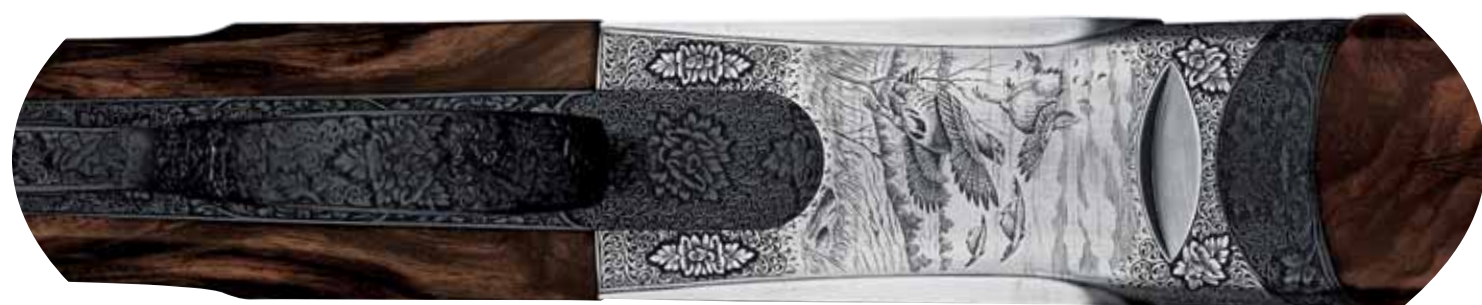

Bottom | Lato inferiore No. 310

SCO CARTELLE

Tipi di incisione applicabili a qualsiasi versione SCO Cartelle



Left side | Lato sinistro No. 36



Right side | Lato destro No. 31

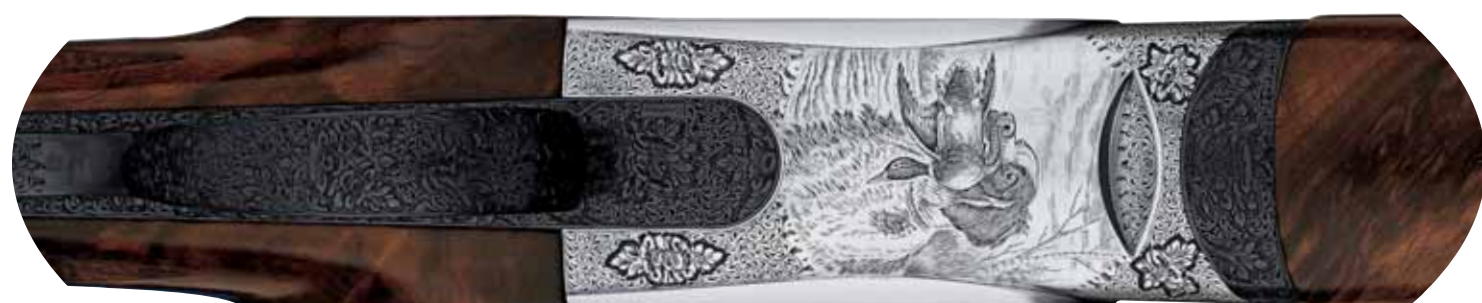

Bottom | Lato inferiore No. 311

SCO SIDEPLATES

Engraving patterns applicable to any SCO Sideplates version



Left side | Lato sinistro No. 341



Right side | Lato destro No. 342



Bottom | Lato inferiore No. 313

SCO CARTELLE

Tipi di Incisione applicabili a qualsiasi versione SCO Cartelle



Left side | Lato sinistro No. 34



Right side | Lato destro No. 39



Bottom | Lato inferiore No. 312

SCO SIDEPLATES - SCO CARTELLE

Engraving patterns applicable to any SCO Sideplates version

Tipi di Incisione applicabili a qualsiasi versione SCO Cartelle



Left and right side | Lato sinistro e destro No. 38



Left and right side | Lato sinistro e destro No. 37



Left and right side | Lato sinistro e destro No. 335

SCO GOLD - SCO ORO

Engraving patterns applicable to any SCO Gold version

Tipi di Incisione applicabili a qualsiasi versione SCO Oro



Left side | Lato sinistro No. 22



Right side | Lato destro No. 21



Bottom | Lato inferiore No. 27

SCO GOLD

Engraving patterns applicable to any SCO Gold version



Left side | Lato sinistro No. 28



Right side | Lato destro No. 29



Bottom | Lato inferiore No. 30

SCO ORO

Tipi di incisione applicabili a qualsiasi versione SCO Oro



Left and right side | Lato sinistro e destro No. 25



Bottom | Lato inferiore No. 25



Left and right side | Lato sinistro e destro No. 112



Bottom | Lato inferiore No. 112

SCO

Engraving patterns applicable to any SCO version



Left side | Lato sinistro No. 63



Right side | Lato destro No. 130

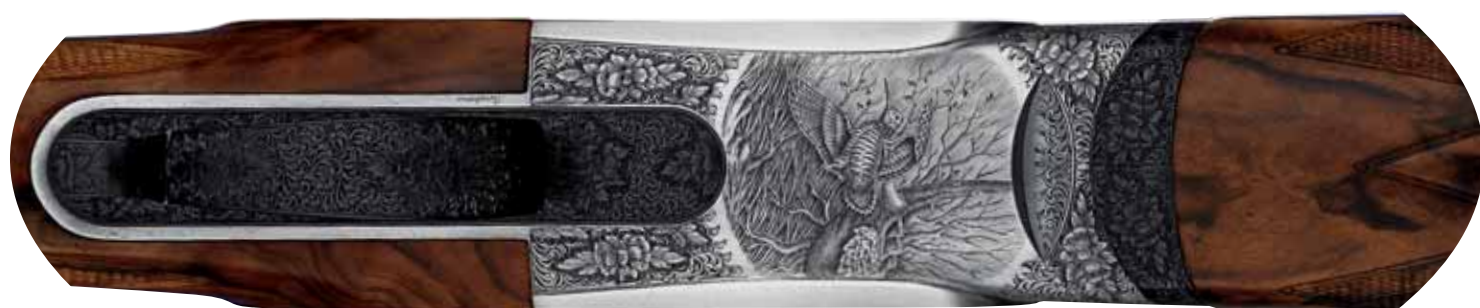

Bottom | Lato inferiore No. 139

SCO

Tipi di incisione applicabili a qualsiasi versione SCO



Left side | Lato sinistro No. 20



Right side | Lato destro No. 123



Bottom | Lato inferiore No. 131

SCO

Engraving patterns applicable to any SCO version



Left side | Lato sinistro No. 15



Right side | Lato destro No. 13



Bottom | Lato inferiore No. 138

SCO

Tipi di incisione applicabili a qualsiasi versione SCO



Left side | Lato sinistro No. 19



Right side | Lato destro No. 122



Bottom | Lato inferiore No. 140

SCO

Engraving patterns applicable to any SCO version



Left side | Lato sinistro No. 132



Right side | Lato destro No. 133



Bottom | Lato inferiore No. 134

SCO

Tipi di incisione applicabili a qualsiasi versione SCO



Left side | Lato sinistro No. 127



Right side | Lato destro No. 128



Bottom | Lato inferiore No. 129

SCO

Engraving patterns applicable to any SCO version



Left and right side | Lato sinistro e destro No. 12



Left and right side | Lato sinistro e destro No. 124



Left and right side | Lato sinistro e destro No. 137

SCO

Tipi di incisione applicabili a qualsiasi versione SCO



Left and right side | Lato sinistro e destro No. 17



Left and right side | Lato sinistro e destro No. 136



Left and right side | Lato sinistro e destro No. 135

SC3

Engraving patterns applicable to any SC3 version



Left side | Lato sinistro No. 6



Right side | Lato destro No. 4



Bottom | Lato inferiore No. 9

SC3

Tipi di incisione applicabili a qualsiasi versione SC3



Left side | Lato sinistro No. 10



Right side | Lato destro No. 109



Bottom | Lato inferiore No. 4

SC3

Engraving patterns applicable to any SC3 version



Left side | Lato sinistro No. 3



Right side | Lato destro No. 5



Bottom | Lato inferiore No. 10

SC3

Tipi di incisione applicabili a qualsiasi versione SC3



Left side | Lato sinistro No. 105



Right side | Lato destro No. 107



Bottom | Lato inferiore No. 108

SC3

Engraving patterns applicable to any SC3 version



Left side | Lato sinistro No. 9



Right side | Lato destro No. 8



Bottom | Lato inferiore No. 3

SC3

Tipi di incisione applicabili a qualsiasi versione SC3



Left and right side | Lato sinistro e destro No. 1



Left and right side | Lato sinistro e destro No. 2



Left and right side | Lato sinistro e destro No. 7



Left and right side | Lato sinistro e destro No. 100

GAME MODELS 12 AND 20 GA



MX2000S 12 ga

Barrel length and chokes	26 3/4" - 27 9/16" - 28 3/8" - 29 1/2" - 4 and 8/10 or on request or with interchangeable chokes
Rib and side ribs	Flat parallel 9/32" x 9/32" rib. With half solid side ribs
Trigger group	Non removable, single selective with coil springs
Stock and forend	English style or pistol grip - Game forend
Features	Engraved frame - Blued frame with name in gold or nickel plated frame without gold in the name



MX2000S/20 20 ga

Barrel length and chokes	26 3/4" - 27 9/16" - 28 3/8" - 29 1/2" - 4 and 8/10 or on request or with interchangeable chokes
Rib and side ribs	Flat parallel 9/32" x 9/32" rib. With half solid side ribs
Trigger group	Non removable, single selective with coil springs
Stock and forend	English style or pistol grip - Game forend
Features	Small frame. Engraved frame - Blued frame with name in gold or nickel plated frame without gold in the name

MODELLI DA CACCIA CAL. 12 E 20



MX2000S cal. 12

Lunghezza canne e strozzature	68-70-72-75 cm - 4 e 8/10 o a richiesta o con strozzatori intercambiabili
Bindella e bindellini	Bindella piana parallela 7 x 7 mm. Con mezzi bindellini pieni
Batteria	Fissa con molle a spirale e selettore sulla sicura
Calcio e asta	Calcio inglese o a pistola - Asta caccia
Caratteristiche	Incisione sulla bascula - Bascula brunita con nome in oro o nichelata senza oro nel nome



MX2000S/20 cal. 20

Lunghezza canne e strozzature	68-70-72-75 cm - 4 e 8/10 o a richiesta o con strozzatori intercambiabili
Bindella e bindellini	Bindella piana parallela 7 x 7 mm. Con mezzi bindellini pieni
Batteria	Fissa con molle a spirale e selettore sulla sicura
Calcio e asta	Calcio inglese o a pistola - Asta caccia
Caratteristiche	Bascula piccola. Incisione sulla bascula - Bascula brunita con nome in oro o nichelata senza oro nel nome

OLYMPIC AND DOUBLE TRAP MODELS 12 AND 20 GA



MX8 12 ga MX8/20 20 ga

Barrel length and chokes	29 1/2" - 30 3/4" - 31 1/2" - 7 and 10/10 or on request or with interchangeable chokes
Rib and side ribs 12 ga	Flat parallel 7/16" x 7/16" or tapered 7/16" x 9/32" rib. With half ventilated side ribs
Rib and side ribs 20 ga	Flat parallel 3/8" x 3/8" or tapered 3/8" x 9/32" rib. With half ventilated side ribs
Trigger group	Removable with flat or coil springs
Stock and forend	Custom made stock - Beavertail forend
Features	Small frame for 20 ga model - Blued or nickel plated



MX2000/8 12 ga MX2000/8-20 20 ga

Barrel length and chokes	29 1/2" - 30 3/4" - 31 1/2" - 7 and 10/10 or on request or with interchangeable chokes
Rib and side ribs 12 ga	Flat parallel 7/16" x 7/16" or tapered 7/16" x 9/32" rib. With half ventilated side ribs
Rib and side ribs 20 ga	Flat parallel 3/8" x 3/8" or tapered 3/8" x 9/32" rib. With half ventilated side ribs
Trigger group	Removable with flat or coil springs
Stock and forend	Custom made stock - Beavertail forend
Features	Small frame for 20 ga model - Engraved frame - Blued frame with name in gold or nickel plated frame without gold in the name

MODELLI DA PIATTELLO E DOUBLE TRAP CAL. 12 E 20



MX8 cal. 12 MX8/20 cal. 20

Lunghezza canne e strozzature	75-78-80 cm - 7 e 10/10 o a richiesta o con strozzatori intercambiabili
Bindella e bindellini cal. 12	Bindella piana parallela 11 x 11 mm o convergente 11 x 7 mm. Con mezzi bindellini ventilati
Bindella e bindellini cal. 20	Bindella piana parallela 10 x 10 mm o convergente 10 x 7 mm. Con mezzi bindellini ventilati
Batteria	Estraibile con molle a lamina o a spirale
Calcio e asta	Calcio a misura - Asta castoro
Caratteristiche	Bascula piccola per il modello cal. 20 - Brunita o nichelata



MX2000/8 cal. 12 MX2000/8-20 cal. 20

Lunghezza canne e strozzature	75-78-80 cm - 7 e 10/10 o a richiesta o con strozzatori intercambiabili
Bindella e bindellini cal. 12	Bindella piana parallela 11 x 11 mm o convergente 11 x 7 mm. Con mezzi bindellini ventilati
Bindella e bindellini cal. 20	Bindella piana parallela 10 x 10 mm o convergente 10 x 7 mm. Con mezzi bindellini ventilati
Batteria	Estraibile con molle a lamina o a spirale
Calcio e asta	Calcio a misura - Asta castoro
Caratteristiche	Bascula piccola per il modello cal. 20 - Incisione sulla bascula - Bascula brunita con nome in oro o nichelata senza oro nel nome

OLYMPIC AND DOUBLE TRAP MODELS 12 AND 20 GA



MX2000/3 12 ga MX2000/3-20 20 ga

Barrel length and chokes	29 1/2" - 30 3/4" - 31 1/2" - 7 and 10/10 or on request or with interchangeable chokes
Rib and side ribs 12 ga	Adjustable rib with 3 notches, parallel 7/16" x 7/16" or tapered 7/16" x 9/32". With half ventilated side ribs
Rib and side ribs 20 ga	Adjustable rib with 3 notches, parallel 3/8" x 3/8" or tapered 3/8" x 9/32". With half ventilated side ribs
Trigger group	Removable with flat or coil springs
Stock and forend	Stock with adjustable comb in wood or rubber - Beavertail forend
Features	Small frame for 20 ga model - Adjustable point of impact - Engraved frame - Blued frame with name in gold or nickel plated frame without gold in the name



MX2005 12 ga

Barrel length and chokes	29 1/2" - 30 3/4" - 31 1/2" - 7 and 10/10 or on request or with interchangeable chokes
Rib and side ribs 12 ga	Adjustable rib with 5 notches, parallel 7/16" x 7/16" or 9/32" x 9/32" or tapered 7/16" x 9/32". With half ventilated side ribs
Trigger group	Removable with flat or coil springs
Stock and forend	Stock with adjustable comb in wood or rubber - Beavertail forend
Features	Adjustable point of impact - Engraved frame - Nickel plated or blued frame without gold in the name



MX2008 12 ga

Barrel length and chokes	29 1/2" - 30 3/4" - 31 1/2" - 7 and 10/10 or on request or with interchangeable chokes
Rib and side ribs 12 ga	Adjustable rib with 5 notches, parallel 7/16" x 7/16" or 9/32" x 9/32" or tapered 7/16" x 9/32". With half ventilated side ribs
Trigger group	Removable with flat or coil springs
Stock and forend	Stock with adjustable comb in wood or rubber - Beavertail forend
Features	Adjustable point of impact - Engraved frame - Nickel plated or blued frame without gold in the name

MODELLI DA PIATTELLO E DOUBLE TRAP CAL. 12 E CAL. 20



MX2000/3 cal. 12 MX2000/3-20 cal. 20

Lunghezza canna e strozzature	75-78-80 cm - 7 e 10/10 o a richiesta o con strozzatori intercambiabili
Bindella e bindellini cal. 12	Bindella regolabile con 3 posizioni, parallela 11 x 11 mm o convergente 11 x 7 mm. Con mezzi bindellini ventilati
Bindella e bindellini cal. 20	Bindella regolabile con 3 posizioni, parallela 10 x 10 mm o convergente 10 x 7 mm. Con mezzi bindellini ventilati
Batteria	Estraibile con molle a lamina o a spirale
Calcio e asta	Calcio con nasello regolabile in legno o gomma - Asta castoro
Caratteristiche	Bascula piccola per il modello cal. 20 - Alzo variabile della rosata - Incisione sulla bascula - Bascula brunita con nome in oro o nichelata senza oro nel nome



MX2005 cal. 12

Lunghezza canna e strozzature	75-78-80 cm - 7 e 10/10 o a richiesta o con strozzatori intercambiabili
Bindella e bindellini cal. 12	Bindella regolabile con 5 posizioni, parallela 11 x 11 mm o 7 x 7 mm o convergente 11 x 7 mm. Con mezzi bindellini ventilati
Batteria	Estraibile con molle a lamina o a spirale
Calcio e asta	Calcio con nasello regolabile in legno o gomma - Asta castoro
Caratteristiche	Alzo variabile della rosata - Incisione sulla bascula - Bascula nichelata o brunita senza oro nel nome



MX2008 cal. 12

Lunghezza canna e strozzature	75-78-80 cm - 7 e 10/10 o a richiesta o con strozzatori intercambiabili
Bindella e bindellini cal. 12	Bindella regolabile con 5 posizioni, parallela 11 x 11 mm o 7 x 7 mm o convergente 11 x 7 mm. Con mezzi bindellini ventilati
Batteria	Estraibile con molle a lamina o a spirale
Calcio e asta	Calcio con nasello regolabile in legno o gomma - Asta castoro
Caratteristiche	Alzo variabile della rosata - Incisione sulla bascula - Bascula nichelata o brunita senza oro nel nome

SPORTING MODELS 12 AND 20 GA



MX8 12 ga MX8/20 20 ga

Barrel length and chokes	27 9/16" - 28 3/8" - 29 1/2" - 31 1/2" - 34" - 7 and 10/10 or on request or with interchangeable chokes
Rib and side ribs 12 ga	Flat tapered 7/16" x 9/32" rib. With half ventilated side ribs
Rib and side ribs 20 ga	Flat tapered 3/8" x 9/32" rib. With half ventilated side ribs
Trigger group	Removable, single selective with flat or coil springs
Stock and forend	Custom made stock - Beavertail forend
Features	Small frame for 20 ga model - Blued or nickel plated



MX12 12 ga MX20 20 ga

Barrel length and chokes	27 9/16" - 28 3/8" - 29 1/2" - 31 1/2" - 34" - 7 and 10/10 or on request or with interchangeable chokes
Rib and side ribs 12 ga	Flat tapered 7/16" x 9/32" rib. With half ventilated side ribs
Rib and side ribs 20 ga	Flat tapered 3/8" x 9/32" rib. With half ventilated side ribs
Trigger group	Non removable, single selective with coil springs
Stock and forend	Custom made stock - Beavertail forend
Features	Small frame for 20 ga model - Blued or nickel plated



MX2000S 12 ga MX2000S/20 20 ga

Barrel length and chokes	27 9/16" - 28 3/8" - 29 1/2" - 31 1/2" - 34" - 7 and 10/10 or on request or with interchangeable chokes
Rib and side ribs 12 ga	Flat tapered 7/16" x 9/32" rib. With half ventilated side ribs
Rib and side ribs 20 ga	Flat tapered 3/8" x 9/32" rib. With half ventilated side ribs
Trigger group	Non removable, single selective with coil springs
Stock and forend	Custom made stock - Beavertail forend
Features	Small frame for 20 ga models - Engraved frame - Blued frame with name in gold or nickel plated frame without gold in the name

MODELLI DA SPORTING CAL. 12 E 20



MX8 cal. 12 MX8/20 cal. 20

Lunghezza canne e strozzature	70-72-75-80-86 cm - 7 e 10/10 o a richiesta o con strozzatori intercambiabili
Bindella e bindellini cal. 12	Bindella piana convergente 11 x 7 mm. Con mezzi bindellini ventilati
Bindella e bindellini cal. 20	Bindella piana convergente 10 x 7 mm. Con mezzi bindellini ventilati
Batteria	Estraibile con molle a lamina o a spirale. Monogrillo selettivo
Calcio e asta	Calcio a misura - Asta castoro
Caratteristiche	Bascula piccola per il modello cal. 20 - Brunita o nichelata



MX12 cal. 12 MX20 cal. 20

Lunghezza canne e strozzature	70-72-75-80-86 cm - 7 e 10/10 o a richiesta o con strozzatori intercambiabili
Bindella e bindellini cal. 12	Bindella piana convergente 11 x 7 mm. Con mezzi bindellini ventilati
Bindella e bindellini cal. 20	Bindella piana convergente 10 x 7 mm. Con mezzi bindellini ventilati
Batteria	Fissa con molle a spirale e selettore sulla sicura
Calcio e asta	Calcio a misura - Asta castoro
Caratteristiche	Bascula piccola per il modello cal. 20 - Brunita o nichelata



MX2000S cal. 12 MX2000S/20 cal. 20

Lunghezza canne e strozzature	70-72-75-80-86 cm - 7 e 10/10 o a richiesta o con strozzatori intercambiabili
Bindella e bindellini cal. 12	Bindella piana convergente 11 x 7 mm. Con mezzi bindellini ventilati
Bindella e bindellini cal. 20	Bindella piana convergente 10 x 7 mm. Con mezzi bindellini ventilati
Batteria	Fissa con molle a spirale e selettore sulla sicura
Calcio e asta	Calcio a misura - Asta castoro
Caratteristiche	Bascula piccola per il modello cal. 20 - Incisione sulla bascula - Bascula brunita con nome in oro o nichelata senza oro nel nome

SKEET MODELS 12 AND 20 GA



MX8 12 ga MX8/20 20 ga

Barrel length and chokes	26 3/4" - 27 9/16" - 28 3/8" - 29 1/2" - Cyl/Cyl or on request or with interchangeable chokes
Rib and side ribs 12 ga	Flat parallel 7/16" x 7/16" or tapered 7/16" x 9/32" rib. With half ventilated side ribs
Rib and side ribs 20 ga	Flat parallel 3/8" x 3/8" or tapered 3/8" x 9/32" rib. With half ventilated side ribs
Trigger group	Removable with flat or coil springs
Stock and forend	Custom made stock - Beavertail forend
Features	Small frame for 20 ga model - Blued or nickel plated



MX2000/8 12 ga MX2000/8-20 20 ga

Barrel length and chokes	26 3/4" - 27 9/16" - 28 3/8" - 29 1/2" - Cyl/Cyl or on request or with interchangeable chokes
Rib and side ribs 12 ga	Flat parallel 7/16" x 7/16" or tapered 7/16" x 9/32" rib. With half ventilated side ribs
Rib and side ribs 20 ga	Flat parallel 3/8" x 3/8" or tapered 3/8" x 9/32" rib. With half ventilated side ribs
Trigger group	Removable with flat or coil springs
Stock and forend	Custom made stock - Beavertail forend
Features	Small frame for 20 ga models - Engraved frame - Blued frame with name in gold or nickel plated frame without gold in the name

MODELLI DA SKEET CAL. 12 E 20



MX8 cal. 12 MX8/20 cal. 20

Lunghezza canne e strozzature	68-70-72-75 cm - CI/CI o a richiesta o con strozzatori intercambiabili
Bindella e bindellini cal. 12	Bindella piana parallela 11 x 11 mm o convergente 11 x 7 mm. Con mezzi bindellini ventilati
Bindella e bindellini cal. 20	Bindella piana parallela 10 x 10 mm o convergente 10 x 7 mm. Con mezzi bindellini ventilati
Batteria	Estraibile con molle a lamina o a spirale
Calcio e asta	Calcio a misura - Asta castoro
Caratteristiche	Bascula piccola per il modello cal. 20 - Brunita o nichelata



MX2000/8 cal. 12 MX2000/8-20 cal. 20

Lunghezza canne e strozzature	68-70-72-75 cm - CI/CI o a richiesta o con strozzatori intercambiabili
Bindella e bindellini cal. 12	Bindella piana parallela 11 x 11 mm o convergente 11 x 7 mm. Con mezzi bindellini ventilati
Bindella e bindellini cal. 20	Bindella piana parallela 10 x 10 mm o convergente 10 x 7 mm. Con mezzi bindellini ventilati
Batteria	Estraibile con molle a lamina o a spirale
Calcio e asta	Calcio a misura - Asta castoro
Caratteristiche	Bascula piccola per il modello cal. 20 - Incisione sulla bascula - Bascula brunita con nome in oro o nichelata senza oro nel nome

PIGEON ELECTROCIBLES MODELS 12 GA



MX1

Barrel length and chokes	27 9/16" - 28 3/8" - 29 1/2" - 7 and 10/10 or on request or with interchangeable chokes
Rib and side ribs	Flat tapered 7/16" x 9/32" rib. With half ventilated side ribs
Trigger group	Removable with flat or coil springs
Stock and forend	Custom made stock - Schnabel forend
Features	Blued or nickel plated frame



MX2000/8

Barrel length and chokes	27 9/16" - 28 3/8" - 29 1/2" - 7 and 10/10 or on request or with interchangeable chokes
Rib and side ribs	Flat tapered 7/16" x 9/32" rib. With half ventilated side ribs
Trigger group	Removable with flat or coil springs
Stock and forend	Custom made stock - Schnabel forend
Features	Engraved frame - Blued frame with name in gold or nickel plated frame without gold in the name



MX2000/3

Barrel length and chokes	27 9/16" - 28 3/8" - 29 1/2" - 7 and 10/10 or on request or with interchangeable chokes
Rib and side ribs	Adjustable rib with 3 notches, tapered 7/16" x 9/32". With half ventilated side ribs
Trigger group	Removable with flat or coil springs
Stock and forend	Stock with adjustable comb in wood or rubber - Beavertail forend
Features	Adjustable point of impact - Engraved frame - Blued frame with name in gold or nickel plated frame without gold in the name

MODELLI DA PICCIONE ED ELICHE CAL. 12



MX1

Lunghezza canne e strozzature	70-72-75 cm - 7 e 10/10 o a richiesta o con strozzatori intercambiabili
Bindella e bindellini	Bindella piana 11 x 7 mm. Con mezzi bindellini ventilati
Batteria	Estraibile con molle a lamina o a spirale
Calcio e asta	Calcio a misura - Asta a becco
Caratteristiche	Bascula brunita o nichelata



MX2000/8

Lunghezza canne e strozzature	70-72-75 cm - 7 e 10/10 o a richiesta o con strozzatori intercambiabili
Bindella e bindellini	Bindella piana 11 x 7 mm. Con mezzi bindellini ventilati
Batteria	Estraibile con molle a lamina o a spirale
Calcio e asta	Calcio a misura - Asta a becco
Caratteristiche	Incisione sulla bascula - Bascula brunita con nome in oro o nichelata senza oro nel nome



MX2000/3

Lunghezza canne e strozzature	70-72-75 cm - 7 e 10/10 o a richiesta o con strozzatori intercambiabili
Bindella e bindellini	Bindella regolabile con 3 posizioni, convergente 11 x 7 mm. Con mezzi bindellini ventilati
Batteria	Estraibile con molle a lamina o a spirale
Calcio e asta	Calcio con nasello regolabile in legno o gomma - Asta castoro
Caratteristiche	Alzo variabile della rosata - Incisione sulla bascula - Bascula brunita con nome in oro o nichelata senza oro nel nome

SPORTING MODELS COMBO SETS 12 GA



MX12

Barrel length and chokes	29 1/2" - 31 1/2" - 34" - 7 and 10/10 or on request or with interchangeable chokes
Rib and side ribs	Flat tapered 7/16" x 9/32" rib. With half ventilated side ribs
Trigger group	Non removable with coil springs and selector
Stock and forend	Custom made stock - Beavertail forend
Features	2 barrels set, with spare barrel fit for gauge reduction tubes - Engraved frame. Blued or nickel plated frame



MX2000S

Barrel length and chokes	29 1/2" - 31 1/2" - 34" - 7 and 10/10 or on request or with interchangeable chokes
Rib and side ribs	Flat tapered 7/16" x 9/32" rib. With half ventilated side ribs
Trigger group	Non removable with coil springs and selector
Stock and forend	Custom made stock - Beavertail forend
Features	2 barrels set, with spare barrel fit for gauge reduction tubes - Engraved frame - Blued frame with name in gold or nikel plated without gold in the name

MODELLI DA SPORTING COMBINATI CAL. 12



MX12

Lunghezza canne e strozzature	75-80-86 cm - 7 e 10/10 o a richiesta o con strozzatori intercambiabili
Bindella e bindellini	Piana convergente 11 x 7 mm. Con mezzi bindellini ventilati
Batteria	Fissa con molle a spirale e selettore sulla sicura
Calcio e asta	Calcio a misura - Asta castoro
Caratteristiche	La canna di ricambio è adatta all'inserimento di tubi riduttori di calibro - Incisione sulla bascula. Bascula brunita o nichelata



MX2000S

Lunghezza canne e strozzature	75-80-86 cm - 7 e 10/10 o a richiesta o con strozzatori intercambiabili
Bindella e bindellini	Piana convergente 11 x 7 mm. Con mezzi bindellini ventilati
Batteria	Fissa con molle a spirale e selettore sulla sicura
Calcio e asta	Calcio a misura - Asta castoro
Caratteristiche	La canna di ricambio è adatta all'inserimento di tubi riduttori di calibro - Incisione sulla bascula - Bascula brunita con nome in oro o nichelata senza oro nel nome

SKEET MODELS COMBO SETS 12 GA



MX8

Barrel length and chokes	28 3/8" - 29 1/2" - 31 1/2" - Cyl-Cyl or on request or with interchangeable chokes
Rib and side ribs	Flat tapered 7/16" x 9/32 With half ventilated side ribs
Trigger group	Removable with flat or coil springs
Stock and forend	Custom made stock - Beavertail forend
Features	2 barrels set, spare barrel fit for gauge reduction tubes - Blued or nickel plated frame



MX2000/8

Barrels length and chokes	28 3/8" - 29 1/2" - 31 1/2" - Cyl-Cyl or on request or with interchangeable chokes
Rib and side ribs	Flat tapered 7/16" x 9/32 With half ventilated side ribs
Trigger group	Removable with flat or coil springs
Stock and forend	Custom made stock - Beavertail forend
Features	2 barrels set, spare barrel fit for gauge reduction tubes - Engraved frame - Blued frame with name in gold or nickel plated frame without gold in the name

MODELLI DA SKEET COMBINATI CAL. 12



MX8

Lunghezza canne e strozzature	72-75-80 cm - CL-CL o a richiesta o con strozzatori intercambiabili
Bindella e bindellini	Piana convergente 11 x 7 mm. Con mezzi bindellini ventilati
Batteria	Estraibile con molle a lamina o a spirale
Calcio e asta	Calcio a misura - Asta castoro
Caratteristiche	La canna di ricambio è adatta all'inserimento di tubi riduttori di calibro - Bascula brunita o nichelata



MX2000/8

Lunghezza canna e strozzature	72-75-80 cm - CL-CL o a richiesta o con strozzatori intercambiabili
Bindella e bindellini	Piana convergente 11 x 7 mm. Con mezzi bindellini ventilati
Batteria	Estraibile con molle a lamina o a spirale
Calcio e asta	Calcio a misura - Asta castoro
Caratteristiche	La canna di ricambio è adatta all'inserimento di tubi riduttori di calibro - Incisione sulla bascula - Bascula brunita con nome in oro o nichelata senza oro nel nome

AMERICAN TRAP MODELS SINGLE BARREL 12 GA



MX15

Barrel length and chokes	32" - 34" - 35" - Full choke or on request or with interchangeable chokes
Rib	Adjustable rib with 6 notches, tapered 7/16" x 9/32"
Trigger group	Removable with flat or coil springs
Stock and forend	Stock with adjustable comb in wood or rubber - Beavertail forend
Features	Adjustable point of impact - Unsingle

MX15

Lunghezza canne e strozzature	81-86-89 cm - 8/10 o a richiesta o con strozzatori intercambiabili
Bindella	Regolabile con 6 posizioni, convergente 11 x 7 mm
Batteria	Estraibile con molle a lamina o a spirale
Calcio e asta	Calcio con nasello regolabile in legno o gomma - Asta castoro
Caratteristiche	Alzo variabile della rosata - Canna inferiore



MX15L

Barrel length and chokes	32" - 34" - 35" - Full choke or on request or with interchangeable chokes
Rib	Adjustable rib with 6 notches, tapered 7/16" x 9/32"
Trigger group	Removable with flat or coil springs
Stock and forend	Stock with adjustable comb in wood or rubber - Beavertail forend
Features	Adjustable point of impact - Unsingle - Engraved frame - Nickel plated

MX15L

Lunghezza canne e strozzature	81-86-89 cm - 8/10 o a richiesta o con strozzatori intercambiabili
Bindella	Regolabile con 6 posizioni, convergente 11 x 7 mm
Batteria	Estraibile con molle a lamina o a spirale
Calcio e asta	Calcio con nasello regolabile in legno o gomma - Asta castoro
Caratteristiche	Alzo variabile della rosata - Canna inferiore - Incisione sulla bascula - Nichelata



MX2000

Barrel length and chokes	32" - 34" - 35" - Full choke or on request or with interchangeable chokes
Rib	Adjustable rib with 5 notches, tapered 7/16" x 9/32"
Trigger group	Removable with flat or coil springs
Stock and forend	Stock with adjustable comb in wood or rubber - Beavertail forend
Features	Adjustable point of impact - Unsingle - Engraved frame - Blued frame with name in gold or nickel plated frame without gold in the name

MX2000

Lunghezza canna e strozzature	81-86-89 cm - 8/10 o a richiesta o con strozzatori intercambiabili
Bindella	Regolabile con 5 posizioni, convergente 11 x 7 mm
Batteria	Estraibile con molle a lamina o a spirale
Calcio e asta	Calcio con nasello regolabile in legno o gomma - Asta castoro
Caratteristiche	Alzo variabile della rosata - Canna inferiore - Incisione sulla bascula - Bascula brunita con nome in oro o nichelata senza oro nel nome



MX2005

Barrel length and chokes	34" - Full choke or on request or with interchangeable chokes
Rib	Adjustable rib with 5 notches, tapered 7/16" x 9/32"
Trigger group	Removable with flat or coil springs
Stock and forend	Stock with adjustable comb in wood or rubber - Beavertail forend
Features	Adjustable point of impact - Unsingle - Engraved frame - Nickel plated or blued frame without gold in the name

MX2005

Lunghezza canne e strozzature	86 cm - 8/10 o a richiesta o con strozzatori intercambiabili
Bindella	Regolabile con 5 posizioni, convergente 11 x 7 mm
Batteria	Estraibile con molle a lamina o a spirale
Calcio e asta	Calcio con nasello regolabile in legno o gomma - Asta castoro
Caratteristiche	Alzo variabile della rosata - Canna inferiore - Incisione sulla bascula - Bascula nichelata o brunita senza oro nel nome

MODELLI DA TRAP AMERICANO MONOCANNA CAL. 12



AMERICAN TRAP MODELS SINGLE BARREL 12 GA



MX8

Barrel length and chokes	32" - 34" - 35" - Full choke or on request or with interchangeable chokes
Rib	Ramped rib , tapered 7/16" x 9/32"
Trigger group	Removable with flat or coil springs
Stock and forend	Custom made stock - Beavertail forend
Features	Top single - Blued or nickel plated frame



MX10RS

Barrel length and chokes	32" - 34" - 35" - Full choke or on request or with interchangeable chokes
Rib	Adjustable rib with 4 notches, tapered 7/16" x 9/32"
Trigger group	Removable, with flat or coil springs
Stock and forend	Stock with adjustable comb in wood or rubber - Beavertail forend
Features	Adjustable point of impact - Unsingle - Blued or nickel plated frame



MX10

Barrel length and chokes	32" - 34" - 35" - Full choke or on request or with interchangeable chokes
Rib	Adjustable rib with 4 notches, tapered 7/16" x 9/32"
Trigger group	Removable with flat or coil springs
Stock and forend	Stock with adjustable comb in wood or rubber - Beavertail forend
Features	Adjustable point of impact - Top single - Blued or nickel plated frame

MODELLI DA TRAP AMERICANO MONOCANNA CAL. 12



MX8

Lunghezza canna e strozzature	81 - 86 - 89 cm - 8/10 o a richiesta o con strozzatori intercambiabili
Bindella	Bindella con rampa, convergente 11 x 7 mm
Batteria	Estraibile con molle a lamina o a spirale
Calcio e asta	Calcio a misura - Asta castoro
Caratteristiche	Canna superiore - Bascula brunita o nichelata



MX10RS

Lunghezza canna e strozzature	81-86-89 cm - 8/10 o a richiesta o con strozzatori intercambiabili
Bindella	Regolabile con 4 posizioni, convergente 11 x 7 mm.
Batteria	Estraibile con molle a lamina o a spirale
Calcio e asta	Calcio con nasello regolabile in legno o gomma - Asta castoro
Caratteristiche	Alzo variabile della rosata - Canna inferiore - Bascula brunita o nichelata



MX10

Lunghezza canna e strozzature	81 - 86 - 89 cm - 8/10 o a richiesta o con strozzatori intercambiabili
Bindella	Regolabile con 4 posizioni, convergente 11 x 7 mm
Batteria	Estraibile con molle a lamina o a spirale
Calcio e asta	Calcio con nasello regolabile in legno o gomma - asta castoro
Caratteristiche	Alzo variabile della rosata - Canna superiore - Bascula brunita o nichelata

AMERICAN TRAP MODELS COMBO SETS 12 GA



MX2000/10

Barrel length and chokes	Single Barrel - 32" - 34" - 35" - Full choke or on request or with interchangeable chokes
Rib	Single Barrel - Adjustable rib with 4 notches, tapered 7/16" x 9/32"
Barrel length and chokes	Over under barrel - 29 1/2" - 31 1/2" - 34" - Im-full choke or on request or with interchangeable chokes
Rib and side ribs	Over under barrel - Adjustable rib with 4 notches, tapered 7/16" x 9/32". With ventilated side ribs or half ventilated side ribs
Trigger group	Removable with flat or coil springs, selector
Stock and forend	Stock with adjustable comb in wood or rubber - Beavertail forend
Features	Adjustable point of impact - Top single - Engraved frame - Blued frame with name in gold or nickel plated frame without gold in the name



MX2000RS

Barrel length and chokes	Single Barrel - 32" - 34" - 35" - Full choke or on request or with interchangeable chokes
Rib	Single Barrel - Adjustable rib with 4 notches, tapered 7/16" x 9/32"
Barrel length and chokes	Over under barrel - 29 1/2" - 31 1/2" - 34" - Im-full choke or on request or with interchangeable chokes
Rib and side ribs	Over under barrel - Adjustable rib with 4 notches, tapered 7/16" x 9/32". With ventilated side ribs or half ventilated side ribs
Trigger group	Removable with flat or coil springs
Stock and forend	Stock with adjustable comb in wood or rubber - Beavertail forend
Features	Adjustable point of impact - Unsingle - Engraved frame - Blued frame with name in gold or nickel plated frame without gold in the name



MX2005

Barrel length and chokes	Single Barrel - 34" - Full choke or on request or with interchangeable chokes
Rib	Single Barrel - Adjustable rib with 5 notches, tapered 7/16" x 9/32"
Barrel length and chokes	Over under barrel - 31 1/2" - Im-full choke or on request or with interchangeable chokes
Rib and side ribs	Over under barrel - Adjustable rib with 5 notches, tapered 7/16" x 9/32". With ventilated side ribs or half ventilated side ribs
Trigger group	Removable with flat or coil springs
Stock and forend	Stock with adjustable comb in wood or rubber - Beavertail forend
Features	Adjustable point of impact - Unsingle - Engraved frame - Nickel plated or blued frame without gold in the name

MODELLI DA TRAP AMERICANO COMBINATI CAL. 12



MX2000/10

Lunghezza canne e strozzature	Canna singola: 81-86-89 cm - 8/10 o a richiesta o con strozzatori intercambiabili
Bindella	Canna singola: bindella regolabile con 4 posizioni, convergente 11 x 7 mm
Lunghezza canne e strozzature	Canna sovrapposta: 75-80-86 cm - 5 e 8/10 o a richiesta o con strozzatori intercambiabili
Bindella e bindellini	Canna sovrapposta: bindella regolabile con 4 posizioni, convergente 11 x 7 mm. Con bindellini ventilati o mezzi bindellini ventilati
Batteria	Estraibile con molle a lamina o a spirale e selettore
Calcio e asta	Calcio con nasello regolabile in legno o gomma - Asta castoro
Caratteristiche	Alzo variabile della rosata - Canna singola superiore - Incisione sulla bascula - Bascula brunita con nome in oro o nichelata senza oro nel nome



MX2000RS

Lunghezza canne e strozzature	Canna singola: 81-86-89 cm - 8/10 o a richiesta o con strozzatori intercambiabili
Bindella	Canna singola: bindella regolabile con 4 posizioni, convergente 11 x 7 mm
Lunghezza canne e strozzature	Canna sovrapposta: 75-80-86 cm - 5 e 8/10 o a richiesta o con strozzatori intercambiabili
Bindella e bindellini	Canna sovrapposta: bindella regolabile con 4 posizioni, convergente 11 x 7 mm. Con bindellini ventilati o mezzi bindellini ventilati
Batteria	Estraibile con molle a lamina o a spirale
Calcio e asta	Calcio con nasello regolabile in legno o gomma - Asta castoro
Caratteristiche	Alzo variabile della rosata - Canna singola inferiore - Incisione sulla bascula - Bascula brunita con nome in oro o nichelata senza oro nel nome



MX2005

Lunghezza canne e strozzature	Canna singola: 86 cm - 8/10 o a richiesta o con strozzatori intercambiabili
Bindella	Canna singola: bindella regolabile con 5 posizioni, convergente 11 x 7 mm
Lunghezza canne e strozzature	Canna sovrapposta: 80 cm - 5 e 8/10 o a richiesta o con strozzatori intercambiabili
Bindella e bindellini	Canna sovrapposta: bindella regolabile con 5 posizioni, convergente 11 x 7 mm. Con bindellini ventilati o mezzi bindellini ventilati
Batteria	Estraibile con molle a lamina o a spirale
Calcio e asta	Calcio con nasello regolabile in legno o gomma - Asta castoro
Caratteristiche	Alzo variabile della rosata - Canna singola inferiore - Incisione sulla bascula - Bascula nichelata o brunita senza oro nel nome

AMERICAN TRAP MODELS COMBO SETS 12 GA



MX10

Barrel length and chokes	Single Barrel - 32" - 34" - 35" - Full choke or on request or with interchangeable chokes
Rib	Single Barrel - Adjustable rib with 4 notches, tapered 7/16" x 9/32"
Barrel length and chokes	Over under barrel - 29 1/2" - 31 1/2" - 34" - Im-full choke or on request or with interchangeable chokes
Rib and side ribs	Over under barrel - Adjustable rib with 4 notches, tapered 7/16" x 9/32". With ventilated side ribs or half ventilated side ribs
Trigger group	Removable with flat or coil springs, selector
Stock and forend	Stock with adjustable comb in wood or rubber - Beavertail forend
Features	Adjustable point of impact - Top single - Blued or nickel plated frame



MX10RS

Barrel length and chokes	Single Barrel - 32" - 34" - 35" - Full choke or on request or with interchangeable chokes
Rib	Single Barrel - Adjustable rib with 4 notches, tapered 7/16" x 9/32"
Barrel length and chokes	Over under barrel - 29 1/2" - 31 1/2" - 34" - Im-full choke or on request or with interchangeable chokes
Rib and side ribs	Over under barrel - Adjustable rib with 4 notches, tapered 7/16" x 9/32". With ventilated side ribs or half ventilated side ribs
Trigger group	Removable with flat or coil springs
Stock and forend	Stock with adjustable comb in wood or rubber - Beavertail forend
Features	Adjustable point of impact - Unsingle - Blued or nickel plated frame

MODELLI DA TRAP AMERICANO COMBINATI CAL. 12



MX10

Lunghezza canne e strozzature	Canna singola: 81-86-89 cm - 8/10 o a richiesta o con strozzatori intercambiabili
Bindella	Canna singola: bindella regolabile con 4 posizioni, convergente 11 x 7 mm
Lunghezza canne e strozzature	Canna sovrapposta: 75-80-86 cm - 5 e 8/10 o a richiesta o con strozzatori intercambiabili
Bindella e bindellini	Canna sovrapposta: bindella regolabile con 4 posizioni, convergente 11 x 7 mm. Con bindellini ventilati o mezzi bindellini ventilati
Batteria	Estraibile con molle a lamina o a spirale e selettore
Calcio e asta	Calcio con nasello regolabile in legno o gomma - Asta castoro
Caratteristiche	Alzo variabile della rosata - Canna singola superiore - Bascula brunita o nichelata



MX10RS

Lunghezza canne e strozzature	Canna singola: 81-86-89 cm - 8/10 o a richiesta o con strozzatori intercambiabili
Bindella	Canna singola: bindella regolabile con 4 posizioni, convergente 11 x 7 mm
Lunghezza canne e strozzature	Canna sovrapposta: 75-80-86 cm - 5 e 8/10 o a richiesta o con strozzatori intercambiabili
Bindella e bindellini	Canna sovrapposta: bindella regolabile con 4 posizioni, convergente 11 x 7 mm. Con bindellini ventilati o mezzi bindellini ventilati
Batteria	Estraibile, con molle a lamina o a spirale
Calcio e asta	Calcio con nasello regolabile in legno o gomma - Asta castoro
Caratteristiche	Alzo variabile della rosata - Canna singola inferiore - Bascula brunita o nichelata

AMERICAN TRAP MODELS COMBO SETS 12 GA



MX8

Barrel length and chokes	Single Barrel - 32" - 34" - 35" - Full choke or on request or with interchangeable chokes
Rib	Single Barrel - Ramped rib, tapered 7/16" x 9/32"
Barrel length and chokes	Over under barrel - 29 1/2" - 31 1/2" - 34" - Im-full choke or on request or with interchangeable chokes
Rib and side ribs	Over under barrel - Ramped rib, tapered 7/16" x 9/32". With ventilated side ribs or half ventilated side ribs
Trigger group	Removable with flat or coil springs, selector
Stock and forend	Custom made stock - Beavertail forend
Features	Top single - Blued or nickel plated frame



MX2000/8

Barrel length and chokes	Single Barrel - 32" - 34" - 35" - Full choke or on request or with interchangeable chokes
Rib	Single Barrel - Ramped rib, tapered 7/16" x 9/32"
Barrel length and chokes	Over under barrel - 29 1/2" - 31 1/2" - 34" - Im-full choke or on request or with interchangeable chokes
Rib and side ribs	Over under barrel - Ramped rib, tapered 7/16" x 9/32". With ventilated side ribs or half ventilated side ribs
Trigger group	Removable with flat or coil springs, selector
Stock and forend	Custom made stock - Beavertail forend
Features	Top single - Engraved frame - Blued frame with name in gold or nickel plated frame without gold in the name

MODELLI DA TRAP AMERICANO COMBINATI CAL. 12



MX8

Lunghezza canne e strozzature	Canna singola: 81-86-89 cm - 8/10 o a richiesta o con strozzatori intercambiabili
Bindella	Canna singola: bindella con rampa, convergente 11 x 7 mm
Lunghezza canne e strozzature	Canna sovrapposta: 75-80-86 cm - 5 e 8/10 o a richiesta o con strozzatori intercambiabili
Bindella e bindellini	Canna sovrapposta: bindella con rampa, convergente 11 x 7 mm. Con bindellini ventilati o mezzi bindellini ventilati
Batteria	Estraibile con molle a lamina o a spirale e selettore
Calcio e asta	Calcio a misura - Asta castoro
Caratteristiche	Canna singola superiore - Bascula brunita o nichelata



MX2000/8

Lunghezza canne e strozzature	Canna singola: 81-86-89 cm - 8/10 o a richiesta o con strozzatori intercambiabili
Bindella	Canna singola: bindella con rampa, convergente 11 x 7 mm
Lunghezza canne e strozzature	Canna sovrapposta: 75-80-86 cm - 5 e 8/10 o a richiesta o con strozzatori intercambiabili
Bindella e bindellini	Canna sovrapposta: bindella con rampa, convergente 11 x 7 mm. Con bindellini ventilati o mezzi bindellini ventilati
Batteria	Estraibile con molle a lamina o a spirale e selettore
Calcio e asta	Calcio a misura - Asta castoro
Caratteristiche	Canna singola superiore - Incisione sulla bascula - Bascula brunita con nome in oro o nichelata senza oro nel nome

AMERICAN TRAP MODELS COMBO SETS 12 GA



MX14

Barrel length and chokes	Single Barrel - 32" - 34" - Full choke or on request or with interchangeable chokes
Rib	Single Barrel - Ramped rib, tapered 7/16" x 9/32"
Barrel length and chokes	Over under barrel - 29 1/2" - 31 1/2" - 1m-full choke or on request or with interchangeable chokes
Rib and side ribs	Over under barrel - Ramped rib, tapered 7/16" x 9/32". With side ribs or half ventilated side ribs
Trigger group	Removable with flat or coil springs, adjustable trigger
Stock and forend	Stock with adjustable comb in wood or rubber - Beavertail forend
Features	Unsingle - Blued or nickel plated frame



MX14L

Barrels length and chokes	Single Barrel - 32" - 34" - Full choke or on request or with interchangeable chokes
Rib	Single Barrel - Ramped rib, tapered 7/16" x 9/32"
Barrels length and chokes	Over under barrel - 29 1/2" - 31 1/2" - 1m-full choke or on request or with interchangeable chokes
Rib and side ribs	Over under barrel - Ramped rib, tapered 7/16" x 9/32". With side ribs or half ventilated side ribs
Trigger group	Removable with flat or coil springs, adjustable trigger
Stock and forend	Stock with adjustable comb in wood or rubber - Beavertail forend
Features	Unsingle - Engraved frame - Nickel plated

MODELLI DA TRAP AMERICANO COMBINATI CAL. 12



MX14

Lunghezza canne e strozzature	Canna singola: 81-86 cm - 8/10 o a richiesta o con strozzatori intercambiabili
Bindella	Canna singola: bindella con rampa, convergente 11 x 7 mm
Lunghezza canne e strozzature	Canna sovrapposta: 75-81 cm - 5 e 8/10 o a richiesta o con strozzatori intercambiabili
Bindella e bindellini	Canna sovrapposta: bindella con rampa, convergente 11 x 7 mm. Con bindellini ventilati o mezzi bindellini ventilati
Batteria	Estraibile con molle a lamina o a spirale - Grilletto regolabile
Calcio e asta	Calcio con nasello regolabile in legno o gomma - Asta castoro
Caratteristiche	Canna singola inferiore - Bascula brunita o nichelata



MX14L

Lunghezza canne e strozzature	Canna singola: 81-86 cm - 8/10 o a richiesta o con strozzatori intercambiabili
Bindella	Canna singola: bindella con rampa, convergente 11 x 7 mm
Lunghezza canne e strozzature	Canna sovrapposta: 75-81 cm - 5 e 8/10 o a richiesta o con strozzatori intercambiabili
Bindella e bindellini	Canna sovrapposta: bindella con rampa, convergente 11 x 7 mm. Con bindellini ventilati o mezzi bindellini ventilati
Batteria	Estraibile con molle a lamina o a spirale - Grilletto regolabile
Calcio e asta	Calcio con nasello regolabile in legno o gomma - Asta castoro
Caratteristiche	Canna singola inferiore - Incisione sulla bascula - Nichelata

CONVERSION TABLES

TAVOLE DI CONVERSIONE

BARREL LENGTH LUNGHEZZA CANNE		RIBS WIDTH LARGHEZZA BINDELLE		CHAMBER CAMERA	
CENTIMETERS CENTIMETRI	INCHES POLLICI	CENTIMETERS CENTIMETRI	INCHES POLLICI	CENTIMETERS CENTIMETRI	INCHES POLLICI
60	23 5/8	11 x 11	7/16 x 7/16	65	2 1/2
66	26	11 x 7	7/16 x 9/32	70	2 3/4
67	26 3/8	10 x 10	3/8 x 3/8	76	3
68	26 3/4	10 x 7	3/8 x 9/32		
70	27 9/16	7 x 7	9/32 x 9/32		
72	28 3/8				
74	29 1/8				
75	29 1/2				
76	30				
78	30 3/4				
80	31 1/2				
81	32				
86	34				
89	35				

CHOKE BORING STROZZATURE				WEIGHTS PESI	
10TH OF MILLIMETER DECIMI DI MILLIMETRO	PERAZZI CODING CODICE PERAZZI	ENGLISH CODING CODICE INGLESE	U.S. CODING CODICE U.S.A.	GRAMS GRAMMI	POUNDS LIBBRE
0	CL	CYL	CYL	453	1 lb
1	CL	CYL	CYL	28	1 oz
2	⊙ ⊙ ⊙ ⊙	IMP. CYL	IMP. CYL	2800	6 lb 3 oz
3	⊙ ⊙ ⊙ ⊙	1/4	IMP. CYL	2900	6 lb 6 oz
4	⊙ ⊙ ⊙	1/4	MODIFIED	3000	6 lb 10 oz
5	⊙ ⊙ ⊙	1/2	MODIFIED	3100	6 lb 14 oz
6	⊙ ⊙ ⊙	1/2	IMP. MOD.	3200	7 lb 1 oz
7	⊙ ⊙	3/4	IMP. MOD.	3300	7 lb 5 oz
8	⊙ ⊙	3/4	FULL	3400	7 lb 8 oz
9	⊙	FULL	FULL	3500	7 lb 12 oz
10	⊙	FULL	X FULL	3600	7 lb 15 oz
11	⊙	X FULL	X FULL	3700	8 lb 3 oz
				3800	8 lb 6 oz
				3900	8 lb 10 oz
				4000	8 lb 13 oz

STANDARD CODES AND MEASUREMENTS OF STOCKS.

Each code number indicates a standard type of stock according to the following scheme: drop at comb and heel, drop at Montecarlo (when indicated), length of pull, cast at heel and toe.

For example: ordering a stock according to European coding, stock code no. 34 corresponds to a stock with 33 mm drop at comb, 33 mm drop at heel, 53 mm drop at Montecarlo, 368 mm length of pull, 5 mm cast off at heel and 10 mm cast off at toe, pistol grip.

Ordering a stock according to the U.S. coding, stock code no. 15 corresponds to a stock with 1 1/2" drop at comb, 2 3/8" drop at heel, no Montecarlo, 14 3/8" length of pull, no cast, pistol grip.

NOTE: available on request custom made stocks, including stocks with adjustable comb.

CODICI E MISURE STANDARD DEI CALCI.

Ogni numero di codice corrisponde ad un tipo di calcio standard in base al seguente schema: piega al nasello e al tallone, piega al Montecarlo (se indicato), lunghezza, deviazione al tallone ed alla punta.

Per esempio: ordinando un calcio in base alla codifica europea, il codice no. 34 corrisponde ad un calcio con 33 mm di piega al nasello, 33 mm di piega al tallone, 53 mm di piega al Montecarlo, 368 mm di lunghezza, 5 mm di deviazione destra al tallone, 10 mm di deviazione destra alla punta, impugnatura a pistola.

Ordinando un calcio in base alla codifica americana, il codice no. 15 corrisponde ad un calcio con 1 1/2 pollice di piega al nasello, 2 3/8 pollici di piega al tallone, senza Montecarlo, 14 3/8 pollici di lunghezza, nessuna deviazione, impugnatura a pistola.

NOTA: a richiesta sono disponibili calci a misura e calci con nasello regolabile.

STANDARD STOCKS - ITALY - EUROPE - WORLD CALCI STANDARD - ITALIA - EUROPA - MONDO								STANDARD STOCKS - U.S.A. - CANADA CALCI STANDARD - U.S.A. - CANADA										
STOCK CODE CODICE CALCIO	DROP AND LENGTH PIEGA E LUNGHEZZA MEASUREMENTS IN MILLIMETERS MISURE IN MILLIMETRI					CAST HEEL DEVIAZIONE TALLONE	TOE PUNTA	STOCK CODE CODICE CALCIO	DROP AND LENGTH PIEGA E LUNGHEZZA MEASUREMENTS IN INCHES MISURE IN POLLICI				MEASUREMENTS IN MILLIMETERS MISURE IN MILLIMETRI				CAST HEEL DEVIAZIONE TALLONE	TOE PUNTA
	A	B	B1	C	D				A	B-B1*	C	D	A	B-B1*	C	D		
No 30	27	37			368	5	10	1	1 3/8	1 3/8*	2 3/16	14 1/2	35	35*	55	368	0	0
31	30	40			368	5	10	2	1 1/4	1 1/4*	2 1/16	14 1/2	32	32*	52	368	0	0
32	30		30	50	368	5	10	3	1 1/8	1 1/8*	1 3/8	14 1/2	29	29*	49	368	0	0
33	32	42			368	5	10	4	1 1/2	1 1/2*	2 1/4	14 1/2	38	38*	58	368	0	0
34	33		33	53	368	5	10	6	1 5/8	1 5/8*	2 3/8	14 1/2	41	41*	61	368	0	0
35	35	45			368	5	10	11	1 1/8	1 1/8		14 1/2	29	29		368	0	0
36	36		36	56	368	5	10	12	1 3/8	1 3/8		14 1/2	35	35		368	0	0
37	35	55			365	5	10	13	1 1/2	1 1/2		14 1/2	38	38		368	0	0
38	40	60			365	5	10	14	1 5/8	1 5/8		14 1/2	41	41		368	0	0
39	35	50			365	5	10	15	1 1/2	2 3/8		14 3/8	38	60		365	0	0
40	37	57			365	5	10	16	1 3/8	2 3/16		14 3/8	35	55		365	0	0
								17	1 3/8	2		14 3/8	35	51		365	0	0
								18	1 7/16	2 1/4		14 3/8	37	57		365	0	0

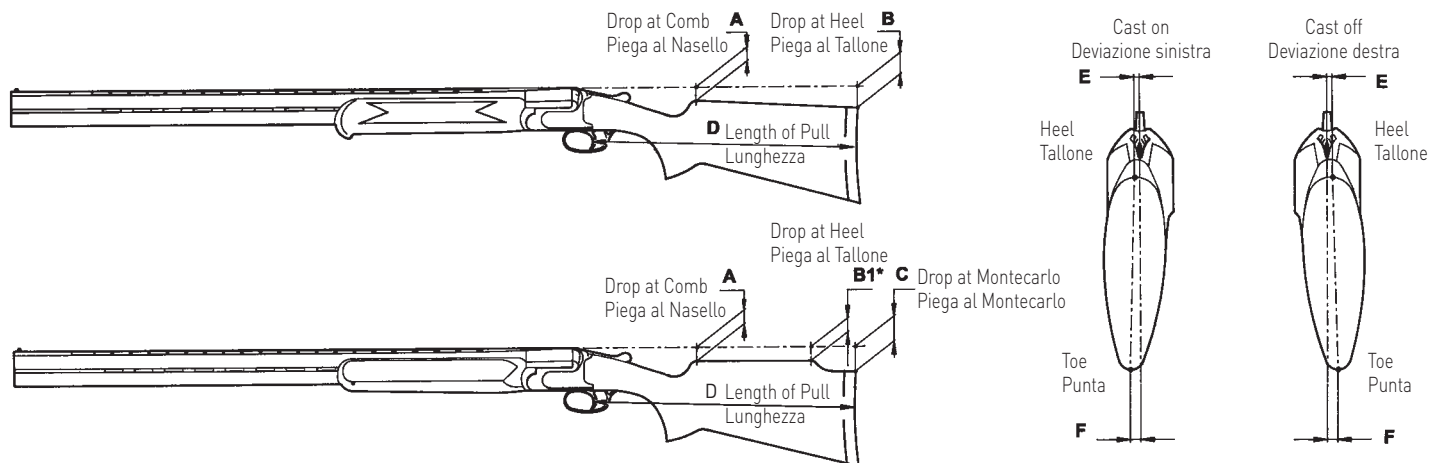

Atlanta 1996

SILVER - ARGENTO

GOLD - ORO

GOLD - ORO

BRONZE - BRONZO



J. Lakatos - USA
Olympic Trap/Fossa Olimpica
MX10

M. Diamond - AUS
Olympic Trap/Fossa Olimpica
MX8

K. Rhode - USA
Double Trap Ladies
MX12

L. Bade - USA
Olympic Trap/Fossa Olimpica
MX8

Perazzi

Sydney 2000

GOLD - ORO



M. Diamond - AUS
Olympic Trap/F.O.
MX8

GOLD - ORO



D. Gudzineviciute - LTU
Olympic Trap/F.O. Ladies
MX8

GOLD - ORO



Z. Meftakhetdinova - AZE
Skeet Ladies
MX8

SILVER - ARGENTO



D. Gelisio - ITA
Double Trap Ladies
MX2000/8

BRONZE - BRONZO



G. Pelliello - ITA
Olympic Trap/F.O.
MX8

BRONZE - BRONZO



F. Al Deehani - KUW
Double Trap
MX8

BRONZE - BRONZO



K. Rhode - USA
Double Trap Ladies
MX12

BRONZE - BRONZO



J. Graves - USA
Skeet
MX8

BRONZE - BRONZO



D. Igaly - HUN
Skeet Ladies
MX8

wins vince

Atene Athens 2004

GOLD - ORO



A. Alipov - RUS
Olympic Trap/F.O.
MX8

GOLD - ORO



S. Balogh - AUS
Olympic Trap/F.O. Ladies
MX8

GOLD - ORO



K. Rhode - USA
Double Trap Ladies
MX12

GOLD - ORO



D. Igaly - HUN
Skeet Ladies
SC3

SILVER - ARGENTO



M. Quintanal - ESP
Olympic Trap/F.O. Ladies
MX2000/8

SILVER - ARGENTO



B. Lee - KOR
Double Trap Ladies
MX8

SILVER - ARGENTO



R. Rathore - IND
Double Trap
MX8

SILVER - ARGENTO



M. Kempainen - FIN
Skeet
MX2000/8

BRONZE - BRONZO



B. Lee - KOR
Olympic Trap/F.O. Ladies
MX8

BRONZE - BRONZO



Z. Wang - CHN
Double Trap
MX2000/8

BRONZE - BRONZO



Z. Meftakhetdinova - AZE
Skeet Ladies
MX8

BRONZE - BRONZO



J. M. Rodriguez - CUB
Skeet
MX8